

# USER MANUAL



Treetech

# TM

Temperature Monitor for Oil and Windings



# Table of Contents

|          |  |           |
|----------|--|-----------|
| <b>1</b> | <b>FOREWORD</b>  | <b>1</b>  |
| 1.1      | LEGAL INFORMATION  | 1         |
| 1.1.1    | <i>Disclaimer</i>  | 1         |
| 1.2      | PRESENTATION   | 1         |
| 1.3      | TYPOGRAPHICAL CONVENTIONS  | 1         |
| 1.4      | GENERAL AND SAFETY INFORMATION   | 1         |
| 1.4.1    | <i>Safety symbols</i>  | 2         |
| 1.4.2    | <i>General symbols</i>   | 2         |
| 1.4.3    | <i>Minimum profile recommended for TM operator and maintainer</i>                  | 2         |
| 1.4.4    | <i>Environmental and voltage conditions required to installation and operation</i> | 3         |
| 1.4.5    | <i>Test and installation instructions</i>  | 3         |
| 1.4.6    | <i>Cleaning and decontamination instructions</i>                                   | 4         |
| 1.4.7    | <i>Inspection and maintenance instructions</i>                                     | 4         |
| 1.5      | CUSTOMER SERVICE   | 6         |
| 1.6      | WARRANTY TERM  | 7         |
| <b>2</b> | <b>INTRODUCTION</b>  | <b>8</b>  |
| 2.1      | FEATURES AND FUNCTIONS   | 9         |
| 2.1.1    | <i>Inputs</i>  | 10        |
| 2.1.2    | <i>Outputs</i>   | 10        |
| 2.1.3    | <i>Communication</i>   | 10        |
| 2.2      | OPTIONAL FUNCTIONS   | 11        |
| 2.2.1    | <i>TM FUNC 3ENR – 3 Winding monitoring</i>   | 11        |
| 2.2.2    | <i>PCOL - Pre-cooling</i>  | 11        |
| 2.2.3    | <i>OLTD - OLTC temperature differential</i>  | 11        |
| 2.3      | BASIC OPERATING PHILOSOPHY   | 14        |
| 2.3.1    | <i>Mass memory (default)</i>   | 14        |
| 2.4      | INTENDED USE   | 14        |
| <b>3</b> | <b>DESIGN AND INSTALLATION</b>   | <b>15</b> |
| 3.1      | SYSTEM TOPOLOGY  | 15        |
| 3.2      | ELECTRICAL INSTALLATION  | 15        |
| 3.2.1    | <i>Input and output terminals</i>  | 17        |
| 3.2.2    | <i>Power supply and grounding</i>  | 19        |
| 3.2.3    | <i>Communication ports</i>   | 19        |
| 3.2.4    | <i>RTD temperature sensors</i>   | 20        |
| 3.2.5    | <i>Analog outputs</i>  | 21        |
| 3.2.6    | <i>Current transformers</i>  | 21        |
| 3.2.7    | <i>Forced cooling control</i>  | 23        |
| 3.3      | MECHANICAL INSTALLATION  | 24        |
| <b>4</b> | <b>OPERATION</b>   | <b>25</b> |
| 4.1      | INITIAL INDICATIONS  | 25        |
| 4.2      | KEY FUNCTIONS  | 26        |
| 4.2.1    | <i>Accessing a submenu</i>   | 26        |
| 4.3      | QUERY SCREENS  | 26        |
| 4.3.1    | <i>General screen</i>  | 27        |
| 4.4      | EQUIPMENT INFORMATION  | 32        |
| <b>5</b> | <b>PARAMETERIZATION</b>  | <b>35</b> |
| 5.1      | ACCESS TO PROGRAMMING MENUS  | 35        |
| 5.2      | PARAMETER MAP  | 36        |
| 5.3      | CLK MENU   | 38        |
| 5.4      | CONF MENU  | 39        |



|          |   |           |
|----------|---|-----------|
| 5.4.1    | <i>GENR Submenu</i> .....                                       | 39        |
| 5.4.2    | <i>COMM Submenu - Communication</i> .....                       | 40        |
| 5.5      | TEMP MENU .....   | 42        |
| 5.5.1    | <i>CONF Submenu - Configuration</i> .....                       | 42        |
| 5.5.2    | <i>ALRM Submenu - Alarms</i> .....                              | 43        |
| 5.5.3    | <i>TRF Submenu - Transformer</i> .....                          | 45        |
| 5.5.4    | <i>COOL Submenu - Forced cooling</i> .....                      | 49        |
| 5.5.5    | <i>TDL Submenu - Temperature differential (Optional)</i> .....  | 51        |
| 5.6      | ADV MENU .....  | 53        |
| 5.6.1    | <i>CONF Submenu</i> .....                                       | 53        |
| 5.6.2    | <i>RELY Submenu</i> .....                                       | 56        |
| 5.6.3    | <i>FACT Submenu</i> .....                                       | 58        |
| <b>6</b> | <b>COMMISSIONING FOR ENTRY INTO SERVICE</b> .....               | <b>59</b> |
| <b>7</b> | <b>TROUBLESHOOTING</b> .....                                    | <b>60</b> |
| 7.1      | EQUIPMENT PRESENTS SELF-DIAGNOSIS MESSAGES ON THE DISPLAY ..... | 60        |
| 7.1.1    | <i>Viewing self-diagnosis memory and alarm memory</i> .....     | 60        |
| <b>8</b> | <b>TECHNICAL DATA AND TYPE TESTS</b> .....                      | <b>63</b> |
| 8.1      | TECHNICAL DATA .....  | 63        |
| <b>9</b> | <b>ORDER SPECIFICATION</b> .....                                | <b>64</b> |



# Table of Illustrations

|   |    |
|---|----|
| Figure 1 - Temperature Monitor for Oil and Windings - TM .....                              | 8  |
| Figure 2 - Temperature measurements of OLTC, transformer and temperature differential ..... | 12 |
| Figure 3 - Instantaneous and filtered temperature differentials .....                       | 13 |
| Figure 4 - Composition of the Temperature Monitoring system .....                           | 15 |
| Figure 5 - TM input and output terminals .....  | 17 |
| Figure 6 - Connection of the interconnection shield between RTD and TM sensors .....        | 21 |
| Figure 7 – Connections details of the current transformers in the Temperature Monitor ..... | 22 |
| Figure 8 - TM dimensions .....  | 24 |
| Figure 9 - TM indications .....   | 25 |
| Figure 10 - TM signaling LEDs .....   | 25 |
| Figure 11 - Command to access equipment information .....                                   | 32 |
| Figure 12 - Display indicating firmware version .....                                       | 32 |
| Figure 13 - Display indicating firmware release version .....                               | 33 |
| Figure 14 - Display indicating bootloader version .....                                     | 33 |
| Figure 15 - Display indicating bootloader release version .....                             | 33 |
| Figure 16 - Display indicating the number of windings .....                                 | 34 |
| Figure 17 - Display indicating part 1 and part 2 of the serial number .....                 | 34 |
| Figure 18 - Menu access structure .....   | 37 |
| Figure 19 - Indication of self-diagnosis in TM .....  | 60 |
| Figure 20 - Querying the self-diagnosis memory .....  | 61 |
| Figure 21 - Alarm memory query screen .....   | 61 |



## Tables

|  |    |
|--|----|
| Table 1 - Operation conditions .....           | 3  |
| Table 2 - TM input terminals .....             | 17 |
| Table 3 - TM output terminals .....            | 18 |
| Table 4 - Programming the cooling stages ..... | 23 |
| Table 5 - TM key functions .....               | 26 |
| Table 6 - TM query screens .....               | 27 |
| Table 7 - TEMP submenu information .....       | 28 |
| Table 8 - CLK submenu information .....        | 30 |
| Table 9 - IEC winding exponent .....           | 48 |
| Table 10 - IEEE winding exponent .....         | 48 |
| Table 11 – Technical data .....                | 63 |



# 1 Foreword

## 1.1 Legal Information

**The information contained in this document is subject to change without notice.**

This document belongs to Treetech Tecnologia Ltda. and may neither be copied, transferred to third parties nor used without express authorization, in terms of Brazilian law 9.610/98.

### 1.1.1 Disclaimer

Treetech Tecnologia Ltda. reserves the right to make changes without prior notice in all products, circuits and functionalities described herein with the aim of improving their reliability, function, or design. Treetech Tecnologia does not assume any liability resulting from application or use of any product or circuit described in here and does not transmit any licenses or patents under its rights, not even third-party rights.

Treetech Tecnologia Ltda. may own patent or other types of registrations and intellectual property rights described in the content of this document. Possession of this document by any person or entity does not give such person or entity any right over these patents or registrations.

## 1.2 Presentation

This manual presents all the recommendations and instructions for installation, operation and maintenance of the Temperature Monitor for Oil and Windings – TM.

## 1.3 Typographical conventions

Throughout this text, the following typographical conventions were adopted:

**Bold:** Symbols, terms and words that are in bold have greater contextual importance. Therefore, pay attention to these terms.

*Italics:* Terms in foreign language, alternative or with their use outside the formal situation are written in italics.

Underlined: References to external documents.

## 1.4 General and safety information

This section presents relevant aspects of safety, installation and maintenance of the TM.



### 1.4.1 Safety symbols

This manual uses three types of risk classification, as shown below:



**Warning:**

This symbol is used to alert the user of potentially dangerous operating or maintenance procedures in which higher caution must be taken. Minor or moderate injuries may occur, as well as damage to the equipment.



**Caution:**

This symbol is used to alert the user of a potentially dangerous operating or maintenance procedure, which demands extreme caution in its conduction. There may occur serious injuries or even death. Possible damages to the equipment may be irreparable.



**Risk of electric shock:**

This symbol is used to alert the user of an operating or maintenance procedure that may result in electric shock if not strictly overseen. There may be minor, moderate, serious injuries or death.

### 1.4.2 General symbols

This manual uses the following general symbols:



**Important**

This symbol is used to highlight important information.



**Tip**

This symbol represents instructions that facilitate the use or access to functions in the TM.

### 1.4.3 Minimum profile recommended for TM operator and maintainer

Installation, maintenance, and operation of equipment in electric power substations require special cares and, therefore, all recommendations of this manual, applicable standards, safety procedures, safe work practices and good judgment must be used during all handling stages of the Temperature Monitor for Oil and Windings - TM.



Only authorized and trained staff – operators and maintainers – should handle this equipment.

To handle the TM, the operator should:

1. Be trained and authorized to operate, ground, turn on and off the TM, following maintenance procedures in accordance with established safety practices, which are the sole responsibility of the TM operator and maintainer;
2. Be trained in the use of PPEs, CPEs and first-aid;
3. Be trained in the working principles of the TM, as well as its configuration;
4. Follow regulatory recommendations regarding interventions in any type of equipment included in an electric power system.

### 1.4.4 Environmental and voltage conditions required to installation and operation

The table below lists important information on the environmental and voltage requirements.

Table 1 - Operation conditions

| Condition                    | Range/description  |
|------------------------------|--|
| Application                  | Equipment for sheltered use in substations, industrial and similar environments. |
| Indoor/outdoor use           | Indoor use   |
| Protection level (IEC 60529) | IP20   |

### 1.4.5 Test and installation instructions

This manual must be available to those responsible for installation and maintenance and for users of the Temperature Monitor for Oil and Windings - TM.

To ensure user safety, equipment protection and correct operation, the following minimum precautions must be followed during the TM installation and maintenance.

1. Please read this manual carefully before installing, operating and maintaining the TM. Errors in the installation, maintenance or adjustments of the TM can cause undue alarms and shutdowns, failing to emit relevant alarms and thus causing misunderstanding of the actual health and functioning of the transformer.
2. The installation, adjustments and operation of the TM must be carried out by trained personnel familiar with power transformers with mineral or vegetable oil insulation, control devices and command circuits of substation equipment.





3. Special attention must be given to the installation of the TM, including the type and gauge of the cables, location of installation and commissioning, including the correct parameterization of the equipment.
4. When carrying out dielectric strength tests on the wiring (applied voltage), disconnect the ground cables connected to terminal 01 of the Temperature Monitor for Oil and Windings – TM, to avoid destroying the overvoltage protections existing inside the devices due to the application of high voltages for a long period (for example, 2 kV for 1 minute). These protections are internally connected between the input/output terminals and ground, clamping the voltage at around 300 V.



The TM must be installed in a sheltered environment (a panel without doors in a control room or a closed panel, in cases of external installation), which does not exceed the temperature and humidity specified for the equipment.



Do not install the TM near heat sources such as heating resistors, incandescent lamps and high-power devices or with heat sinks. It is also not recommended to install it close to ventilation holes or where it can be reached by forced air flow, such as the exit or entry of cooling fans or forced ventilation ducts.



If the panel on which the TM was installed has a window, use a G20 film - or higher - to prevent direct sunlight (ultraviolet rays) from entering the equipment. If the glass in this window is dark, this procedure is not necessary.

### 1.4.6 Cleaning and decontamination instructions

Be careful when cleaning the TM. ONLY use a damp cloth with soap or detergent diluted in water to clean the cabinet, front mask or any other part of the equipment. Do not use abrasive materials, polishes, or aggressive chemical solvents (such as alcohol or acetone) on any of its surfaces.

### 1.4.7 Inspection and maintenance instructions

For inspection and maintenance of the TM, the following observations must be followed:



Do not open your equipment. There are no user-serviceable parts. This must be done by Treotech technical assistance, or technicians accredited by them.  
This equipment is completely maintenance-free, and visual and operational inspections, whether periodic or not, can be carried out by the user. These inspections are not mandatory.



All parts of this equipment must be supplied by Treetech, or one of its accredited suppliers, in accordance with its specifications. If the user wishes to acquire them in another way, they must strictly follow the Treetech specifications for this. This way, performance and safety for the user and the equipment will not be compromised. If these specifications are not followed, the user and the equipment may be exposed to unforeseen risks if this recommendation is not followed.



Opening the TM at any time will result in the loss of the product warranty. In cases of improper opening, Treetech will also not be able to guarantee its correct operation, regardless of whether the warranty period has expired or not.



## 1.5 Customer service

Do you already know our online customer service platform?

[CS](#)



A quick and direct communication channel with our support team is available on the CS page. Ask questions, solve problems, and keep up to date with the application of your Treotech product.

The Treotech knowledge base is also available, including catalogues, manuals, application notes, frequently asked questions, and others.



In some cases, it will be necessary to send the equipment to Treotech Technical Assistance. At the CS we present all the necessary procedures and contacts.



## 1.6 Warranty term

The Temperature Monitor for Oil and Windings - TM, will be guaranteed by Treetech for a period of 2 (two) years, counting from the date of purchase, exclusively against any manufacturing defects or quality defects that make it unsuitable for regular use.

The warranty will not cover damage suffered by the product because of accidents, abuse, incorrect handling, incorrect installation and application, inadequate testing or in the event of the warranty seal being broken.

Any need for technical assistance must be communicated to Treetech or its authorized representative, presenting the equipment accompanied by proof of purchase.

No express or implied warranties other than those cited above are provided by Treetech. Treetech does not provide any guarantee of suitability of the TM for a particular application.

Seller shall not be liable for any type of damage to property or for any losses or damages arising out of, connected with, or resulting from the purchase of the equipment, the performance thereof, or any service possibly provided in conjunction with the TM.

Under no circumstances will the seller be held responsible for losses incurred, including, but not limited to: loss of profits or income, inability to use the TM or any associated equipment, capital costs, costs of purchased energy, costs of equipment, installations or substitute services, downtime costs, claims from customers or employees of the buyer, regardless of whether said damages, claims or losses are based on contract, warranty, negligence, tort or otherwise. Under no circumstances will the seller be held liable for any personal injury of any kind.

## 2 Introduction



Figure 1 - Temperature Monitor for Oil and Windings - TM

The Temperature Monitor for Oil and Windings – TM, by Treetech, has a complete system for monitoring temperatures in transformers and reactors immersed in oil. As it is a modular system, it can be used in simple applications that require low cost, as well as in complete monitoring systems.

The IED promotes all control, command and thermal protection of power transformers and reactors. It monitors oil, winding and on-load tap changer temperatures, as well as the refrigeration system. The measurement of the oil temperature is done directly, adding a Pt100Ω at 0°C to the thermal well for accessing the equipment's oil, while the measurement of the winding temperature is done indirectly behind the thermal image calculation.



## 2.1 Features and functions

### IED (*Intelligent Electronic Device*)

This IED has a modern and compact design, being specifically designed for applications in transformers in substations and industrial or commercial installations.

### Daily cooling activation

The daily cooling activation function prevents fan inactivity during periods of low load or low ambient temperature.

- ✓ 2 forced cooling groups that can act individually or together;
- ✓ Applicable as pre-cooling in transformers subject to predictable cyclic loads, and can act before a load peak;
- ✓ Automatic switching of forced cooling groups.

### Alarms and self-diagnoses

Issuance of alarms in case of abnormalities and self-diagnosis to detect internal faults and integration with other sensors.

### Communication protocol

RS-485 serial communication port for integration into supervision or remote monitoring systems. Modbus® RTU or DNP3 open communication protocols.

### Indirect winding temperature measurement

Temperature measurement of up to three windings using algorithms based on standards and transformer parameters.

### Temperature measurement

Measurement of up to two temperatures, in which it is possible to choose between: ambient temperature, transformer oil temperature and/or OLTC oil temperature. Up to 2 PT100 3-wire sensors can be used.

### Final gradient prediction

Calculation of final oil-winding temperature gradient prediction for ongoing load.

### Mass memory (default)

Non-volatile memory for storing measurements and alarm events, shutdowns, and others. User programming of the interval between recordings and temperature and voltage variation for recording.

### Local cooling control

Cooling operation selectable via front keypad, automatically or manually, or remotely, via communication protocol.

### Multigradient function

The TM has a multigradient function, as the thermal behavior of a transformer varies according to the activation of its cooling stages. This functionality allows the equipment to vary thermal parameters according to the active cooling stage.

### Robust hardware

The TM design exceeds EMC (Electromagnetic Compatibility) standards to withstand severe substation electromagnetic conditions and operating temperatures from -40 to 85 °C.



## 2.1.1 Inputs

- ✓ Input for power supply from 85 to 265 Vdc/Vac, 50/60 Hz;
- ✓ Inputs for PT100 sensors with self-calibration, accuracy of 0.2% of full scale and high stability over a wide range of ambient temperatures;
- ✓ Universal True RMS AC current inputs from 0 to 10 A, accuracy 0.5% of full scale for load measurement and winding temperature calculation using the thermal imaging process.

## 2.1.2 Outputs

- ✓ NO (normally open) contacts for shutdowns due to oil and winding temperatures with double safety in activation (simultaneous order of the 2 microcontrollers for operation). Adjustable timer from 0 to 20 minutes with countdown on display;
- ✓ NC (normally closed) contacts for activating up to 2 forced cooling groups with time delay between the groups starting (even with a lack of power supply to the TM) and forced operation by self-diagnosis routines in case of failure or lack of voltage;
- ✓ NC contacts to indicate internal fault or lack of voltage detected by self-diagnosis;
- ✓ Current outputs for remote temperature indications, with output range selection (0...1, 0...5, 0...10, 0...20 or 4...20 mA).

## 2.1.3 Communication

- ✓ 2 RS-485 serial communication ports;
- ✓ 1 USB Device type C;
- ✓ Modbus® RTU or DNP3 communication protocol, with support for timestamp, capable of signaling events such as alarms, shutdowns, refrigeration activation, etc., with an accuracy of 1 ms.



## 2.2 Optional functions

Depending on the order, the TM can be supplied with one or more of the optional functions listed below:

### 2.2.1 TM FUNC 3ENR – 3 Winding monitoring

This function allows you to choose the number of windings to be activated. You can select the desired number of windings:

- ✓ Temperature measurement of up to three windings - Based on the temperature readings of the insulating oil and one or more transformer load currents;
- ✓ TM calculates the temperature of up to three windings (thermal image).

### 2.2.2 PCOL - Pre-cooling

It extends the useful life of the insulation by activating the cooling groups when load levels previously selected by the user are reached. Forced cooling is triggered before the temperature rises excessively, providing greater efficiency and safety. The features/functions are:

- ✓ Load percentage for individual activation of each forced cooling stage;
- ✓ Hysteresis adjustment to turn off forced cooling stages when loading decreases.

### 2.2.3 OLTD - OLTC temperature differential

The on-load tap changer is one of the main sources of failures in transformers, and the measurement of the temperature difference between the transformer oil and the tap changer oil can indicate thermal failures in this equipment before they get to a degree of severity that could cause major problems. As this temperature difference is subject to influence of external variables, its monitoring is carried out in two distinct modes, in order to increase the efficiency of the diagnosis and avoid false alarms:

- ✓ Monitoring of the instantaneous differential;
- ✓ Monitoring of the differential with filtering.

Some of the most common failure modes in tap changers are related to deteriorated contacts or to mechanical maladjustments that cause the contact resistance to rise and lead to significant heating, which tends to increase this resistance even more in a cascade effect that culminates in complete failure, generally with a high degree of severity.

In three-phase transformers with three single-phase tap changers in individual compartments, the three temperature differentials are calculated in relation to the transformer oil temperature.

In normal operating conditions, the tap changer is a little significant source of heating compared to the heat generated by the transformer losses, so that the temperature of the oil in the tap changer tank is mainly influenced by the transformer oil temperature. The graph in the following figure, elaborated from actual measurements, exemplifies this situation. In



In addition to the transformer and tap changer individual temperatures, the temperature difference between the tap changer and the transformer is also monitored for detecting defects such as the ones mentioned above.

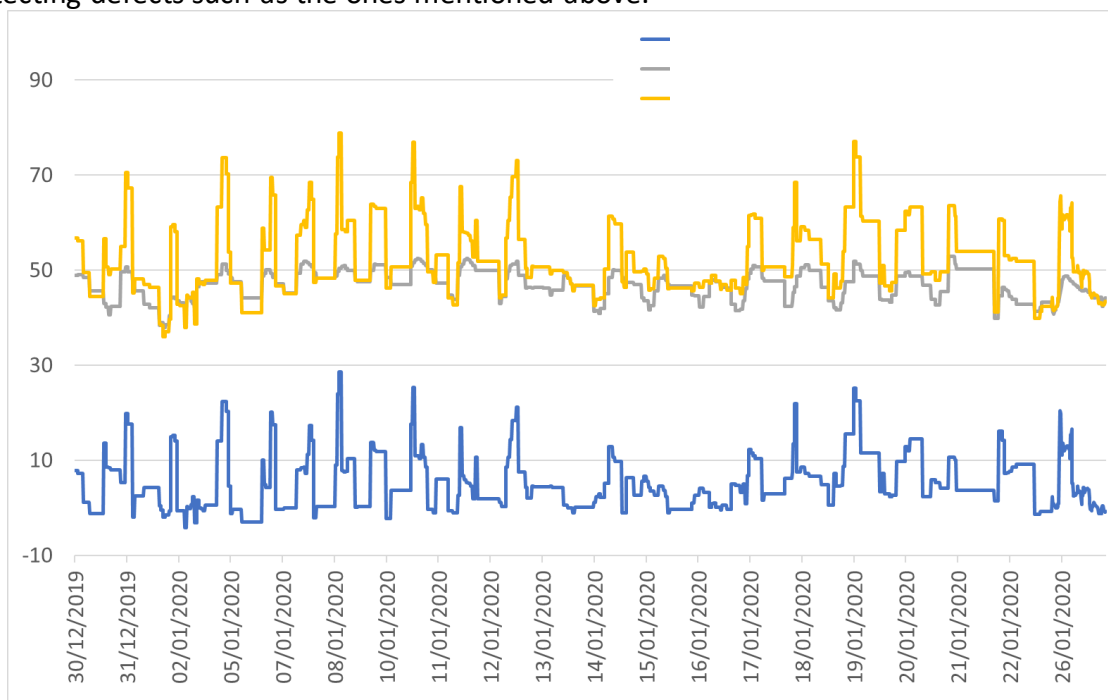

Figure 2 - Temperature measurements of OLTC, transformer and temperature differential

As the **temperature differential** is subject to the influence of external variables, such as forced cooling activation, rapid variations in atmospheric conditions and others, monitoring is carried out in two different modes, illustrated in the next figure, in order to increase diagnostic efficiency and avoid false alarms:

- **Instantaneous differential monitoring** - Monitoring the instantaneous temperature differential provides alarms with quick response in the event of major defects, even if of short duration.
- **Filtered differential monitoring** - The filtered temperature differential is obtained by subjecting the instantaneous differential to a low-pass filter with a user-adjustable time constant. Its monitoring makes it possible to detect trends in differential evolution that indicate permanent defects of low intensity, although with a longer detection time.

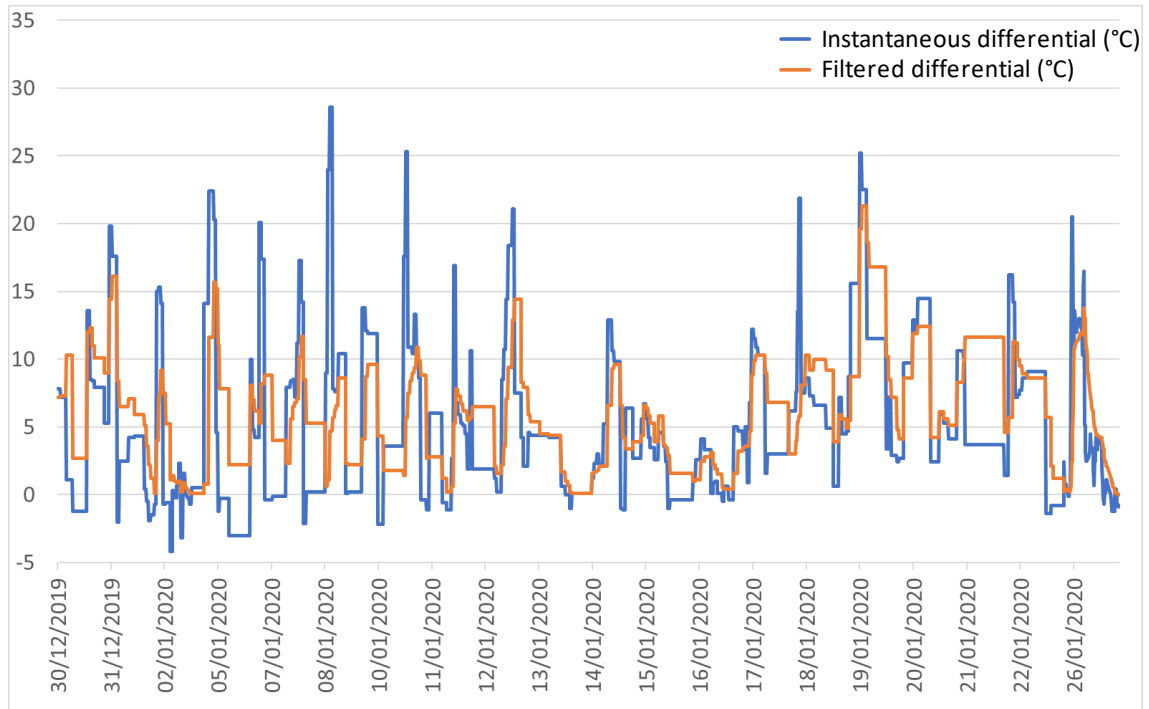

Figure 3 - Instantaneous and filtered temperature differentials

The alarm settings for instantaneous and filtered temperature differentials can be determined automatically by the Temperature Monitor, through a period of learning the normal behavior of the tap changer. The user can later change these alarms manually.

The duration of this learning period can be adjusted by the user, typically lasting one week. During this period, the maximum values reached by the instantaneous and filtered temperature differentials are recorded, and a programmed tolerance margin is added to these maximum values, thus obtaining the instantaneous and filtered differential alarm values respectively.

Just like the transformer oil temperature, the measurement of the on-load tap changer oil temperature is carried out using a PT100Ω sensor at 0 °C, which is connected to an available input on the TM. The Oil and Winding Temperature Monitor has 2 inputs available for PT100 sensors; at least one of them must be used for transformer oil temperature, and the other can be used for redundant measurement of transformer oil or for OLTC, ambient or other temperatures.



## 2.3 Basic operating philosophy

The oil temperature is measured directly, adding a PT100Ω at 0°C to the equipment's oil access thermal well, while the winding temperature is measured indirectly through thermal image calculation. The IED promotes all control, command and thermal protection of power transformers and reactors. Monitors oil, winding, and on-load tap changer temperatures as well as the cooling system.

The measurement of the transformer load current is carried out through the secondary of one or more current transformers (CTs) that connect to the TM through external split-core window CTs.

The TM has 2 forced cooling groups, in manual or automatic mode, responsible for activating the fans or cooling pumps. This occurs when the reading of one of the RTDs is higher than that configured for activation, to cool the transformer that is being monitored, with its activation temperatures and the hysteresis for shutdown being programmable.

If the optional pre-cooling function is available, forced cooling can also be controlled based on the percentage loads of the windings, considering the highest measured load. The pre-cooling function means that, due to the thermal inertia of the oil and windings, the cooling groups are activated before the transformer reaches the temperature levels pre-established in the settings for automatic control, thus reducing the average temperature of transformer operation.

### 2.3.1 Mass memory (default)

Non-volatile memory for storing temperature measurements and alarm occurrences.

A memory write can be initiated by:

- ✓ User-selected time interval between recordings;
- ✓ Variation in any of the temperatures greater than the deadband value selected by the user, in °C;
- ✓ Change of state of any of the output relays (cooling control, alarms, shutdowns, or self-diagnosis).

## 2.4 Intended use

The intended use of the Temperature Monitor for Oil and Windings – TM is to facilitate the monitoring of oil temperatures in transformers, windings, and on-load tap changers (if the differential option is enabled).

The measurement of the oil temperature is done directly, adding a Pt100 Ω at 0°C to the thermal well for accessing the equipment's oil, while the measurement of the winding temperature is done indirectly behind the thermal image calculation.

## 3 Design and installation

### 3.1 System topology

Basically, the Oil and Winding Temperature Monitoring system is composed of:

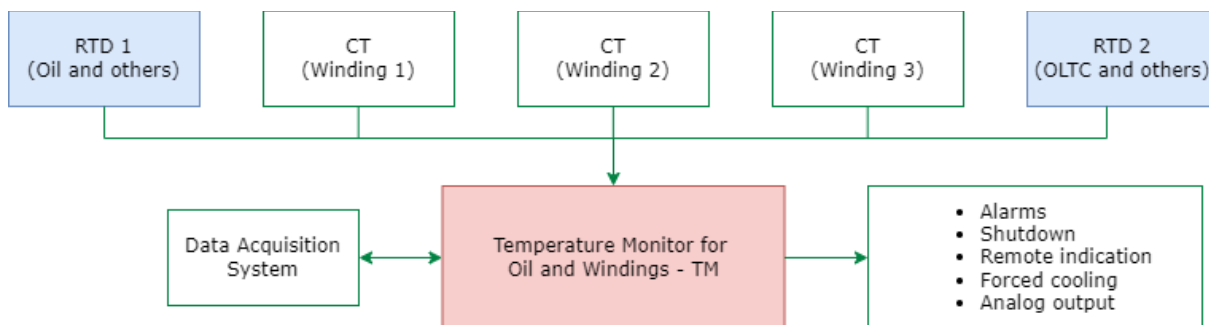

Figure 4 - Composition of the Temperature Monitoring system

The items required for the system are:

- Temperature Monitor for Oil and Windings – TM;
- External split-core window CTs (clip-on) for current measurement for thermal imaging. The quantity varies depending on the thermal monitoring application (1 or 3 windings);
- Three-way shielded cables for connecting the RTD sensor;
- Two-way shielded twisted-pair cables for serial communication;
- Box for outdoor installation;
- RTD sensors type PT100  $\Omega$  at 0 °C for measuring temperatures.

### 3.2 Electrical installation

The TM is a versatile piece of equipment that can meet different applications. Therefore, its installation requires a greater level of study and care than equipment dedicated exclusively to a single application or task. The TM has different electrical installation configurations. These settings are determined by whether the application in question will use the features and options available.



Study and understand the application in which you intend to use the TM. Know the functional, electrical and configuration characteristics. This way you will be able to take full advantage of the equipment and minimize risks to your safety.



This equipment works at dangerous levels of supply voltage, which may cause death or serious injury to the operator or maintainer.

Some special care must be followed for the design and installation of the TM, as described below:



A circuit breaker must be used immediately before the power input (Universal power supply - 85 ~ 265 Vac/Vdc, <12 W, 50/60 Hz), which corresponds to pins 02 and 03 of the TM.

The circuit breaker must have the number of poles corresponding to the number of phases used in the power supply, and the poles must only interrupt the phases, and never the neutral or ground, and provide thermal and electrical protection to the conductors that supply the equipment and must be close to the equipment and easily maneuverable by the operator.

Additionally, it must have an indelible identification showing that it is the electrical disconnection device of the TM.



The following circuit breaker specification is recommended when used exclusively for the TM:

- AC/DC power supply, Phase-Neutral: Single-pole circuit breaker,  $1\text{ A} \leq I_n \leq 2\text{ A}$ , curve B or C standards NBR/IEC 60947-2, NBR/IEC 60898 or IEEE 1015-2006;
- AC/DC power supply, Phase-Phase: Bipolar circuit breaker,  $1\text{ A} \leq I_n \leq 2\text{ A}$ , curve B or C, standards NBR/IEC 60947-2, NBR/IEC 60898 or IEEE 1015-2006.



The minimum isolation for circuits connected to the TM is 300 Vrms for auxiliary equipment and transducers, such as PT100, window CTs (clip-on) powered by the TM and for equipment with its own power supply up to 50 Vrms.

The minimum insulation is 1.7 kV rms for equipment powered up to 300 Vrms, in accordance with IEC EN 61010-1.

These values are related to the intrinsic insulation of the devices connected to the TM. Cases in which these values do not apply to equipment or devices connected to the TM will be explicitly informed in this manual.

The standard TM connection schematic diagram shows all connection possibilities, identifying them, as shown in the following figure.

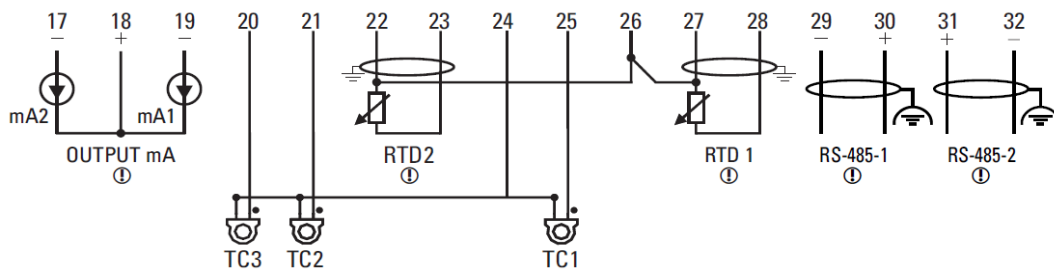

# TM

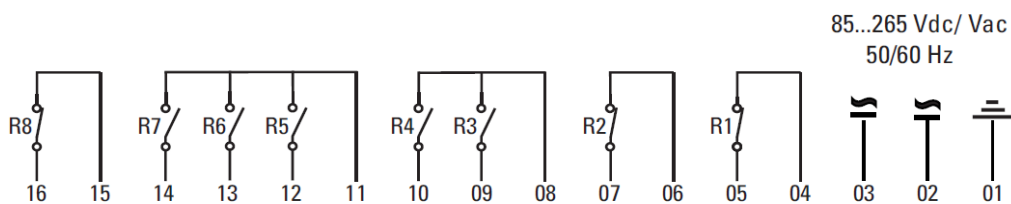

Figure 5 - TM input and output terminals

## 3.2.1 Input and output terminals

The Temperature Monitor for Oil and Windings has the following inputs and outputs:

Table 2 - TM input terminals

| Inputs  | Terminals  |
|---|--|
| <b>Power Supply and Grounding</b><br>Power input 85 to 265 Vdc/Vac, 50/60 Hz, <12 W.  | 01 — Ground<br>02 — dc/ac<br>03 — dc/ac  |
| <b>USB Type-C Port</b><br>Connection to external computer, for log download and updates.  | Located in the lower left corner on the front of the device.                         |
| <b>RS-485 Ports — Serial Communication Network with Monitoring or Supervisory System</b><br>Connection to a monitoring or supervisory system using the Modbus®RTU or DNP3 protocol.<br>Use twisted pair and shielded cable. | <b>RS485-1</b><br>29 — (-)<br>30 — (+)<br><br><b>RS485-2</b><br>31 — (+)<br>32 — (-) |

|  |   |
|--|---|
| <p><b>Temperature Sensors — RTD</b></p> <p>Input for direct connection of PT100 <math>\Omega</math> at 0 °C sensor, in three-wire measurement configuration.</p> | <p><b>RTD 1</b></p> <p>26 — (Red)<br/>27 — (White)<br/>28 — (Red)</p> <p><b>RTD 2</b></p> <p>22 — (White)<br/>23 — (Red)<br/>26 — (Red)</p> |
| <p><b>Current Inputs</b></p> <p>Input for clip-on window CT connection.</p>  | <p>20 — I<sub>en</sub> 1<br/>21 — I<sub>en</sub> 2<br/>24 — Common<br/>25 — I<sub>en</sub> 3</p>  |

Table 3 - TM output terminals

| Outputs   | Terminals        |
|---|------------------|
| <p><b>Relay 01 — Cooling group 1</b></p> <p>A potential-free NC (Normally Closed) relay, intended for cooling group 1 commands.</p>                 | <p>04 and 05</p> |
| <p><b>Relay 02 — Self-diagnosis</b></p> <p>A potential-free NC (Normally Closed) relay for self-diagnosis.</p>                                      | <p>06 and 07</p> |
| <p><b>Relay 03 — Oil shutdown</b></p> <p>A potential-free NO (Normally Open) relay for oil shutdown.</p>  | <p>08 and 09</p> |
| <p><b>Relay 04 — Shutdown of windings 1, 2 and 3</b></p> <p>A potential-free NO (Normally Open) relay for switching off windings 1, 2 and/or 3.</p> | <p>08 and 10</p> |
| <p><b>Relay 05 — Parameterizable</b></p> <p>A potential-free, configurable NO (Normally Open) relay.</p>  | <p>11 and 12</p> |
| <p><b>Relay 06 — Parameterizable</b></p> <p>A potential-free, configurable NO (Normally Open) relay.</p>  | <p>11 and 13</p> |
| <p><b>Relay 07 — Parameterizable</b></p> <p>A potential-free, configurable NO (Normally Open) relay.</p>  | <p>11 and 14</p> |

|   |  |
|---|--|
| <b>Relay 08 — Cooling group 2</b><br>A potential-free NC (Normally Closed) relay, intended for cooling group 2 commands .   | 15 and 16  |
| <b>Analog current loop outputs (mA)</b><br>Two outputs for remote indication of different quantities, the output pattern is also selected by the user from the options: 0... 1, 0... 5, 0... 10, 0... 20 or 4... 20 mA. | <b>mA 1</b><br>18 (+)<br>19 (-)<br><b>mA 2</b><br>17 (-)<br>18 (+) |

### 3.2.2 Power supply and grounding

The TM has a universal power input from 85 to 265 Vdc/Vac, at a frequency of 50 or 60 Hz.

### 3.2.3 Communication ports

#### 3.2.3.1 USB Type-C

The TM has a USB Type-C communication port located on its front. This port has a fixed address of 247 and the available communication protocols are Modbus® RTU and DNP3 in only 1 instance.

#### 3.2.3.2 RS-485 serial communication

The TM provides 2 serial communication ports that can be connected to a data acquisition system (supervisory or monitoring system).

Up to 31 devices can be interconnected in the same communication network. The available communication protocols are Modbus® RTU and DNP3.

Although the DNP3 protocol is available on all communication ports, its use is limited to just one of them, selectable by the user.

The interconnection between the TM and the data acquisition system must be carried out using a shielded twisted pair cable, maintaining the continuity of the mesh along the entire route. If it is necessary to use intermediate terminals to interconnect serial communication, the cable shield must also be passed through these terminals, avoiding interruption. The cable section without shielding due to splicing must be as short as possible, and it is advisable that the cable shield is grounded at only one end. The maximum distance between the ends of the communication network must be 1200 meters and must be followed.





In case of communication problems, especially when there are long networks (distance greater than 1000 m) and high transmission rates (greater than 9600 bps), the use of a 120  $\Omega$  termination resistor at each end of the serial communication network can resolve these transmission errors by attenuating signal reflections in the cable.

Another measure that can be tried is installing pull-up and pull-down resistors at just one point on the network. The 5 V continuous voltage for powering the pull-up and pull-down resistors can be supplied internally by the data acquisition system. It is important to note that some communication equipment may already have these resistors installed internally, eliminating the need for external resistors.

### 3.2.4 RTD temperature sensors

Two inputs are available for RTD temperature sensors, which must be connected to the TM via shielded cables, maintaining loop continuity. These cables must be grounded only at the end connected to the TM, as close to it as possible.



The maximum resistance for each of the paths used in the TM interconnection cable with the PT100 sensors is 3  $\Omega$ . In other words, 6  $\Omega$  for the round trip from the PT100 sensor to the TM.



Considering the maximum resistance allowed in the connection between the PT100 and the TM, for a copper cable with a gauge of 1.5 mm<sup>2</sup>, the PT100 can be installed at a maximum distance of 265 m from the TM. Other values will be possible with the correct cable sizing. If you need support for cable sizing, contact Treetech CS.

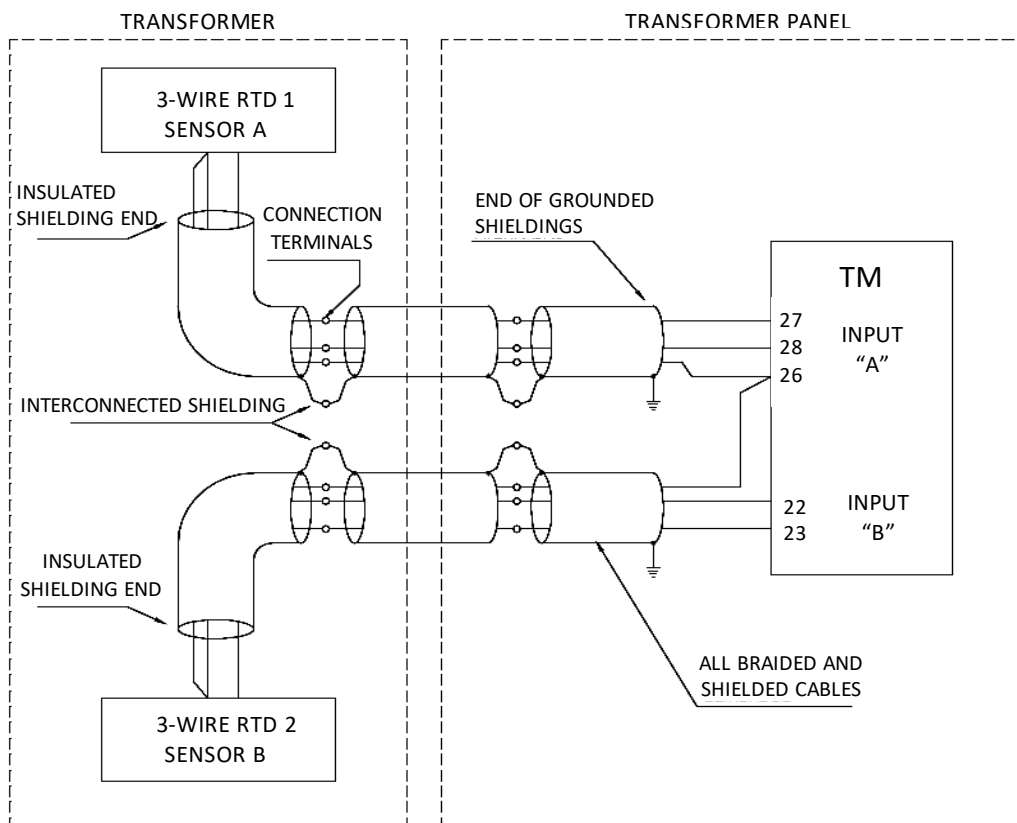

Figure 6 - Connection of the interconnection shield between RTD and TM sensors

### 3.2.5 Analog outputs

The analog signaling circuit (mA output) must be interconnected using a shielded twisted pair cable, keeping the mesh uninterrupted until its termination at the specific input of the devices, grounding only at the end closest to the equipment.

If there is a need for intermediate terminals to interconnect the current outputs, also pass the cable mesh through a terminal, avoiding interruption. The unshielded cable section due to splicing must be as short as possible.



Both outputs referring to pins 17 and 19 are interconnected, resulting in a common positive.



The use of inappropriate cables for RS-485 communication and mA output may compromise the TM's performance.

Always use the recommended cables.

### 3.2.6 Current transformers

Connection of current transformers must be carried out in accordance with the instructions below:

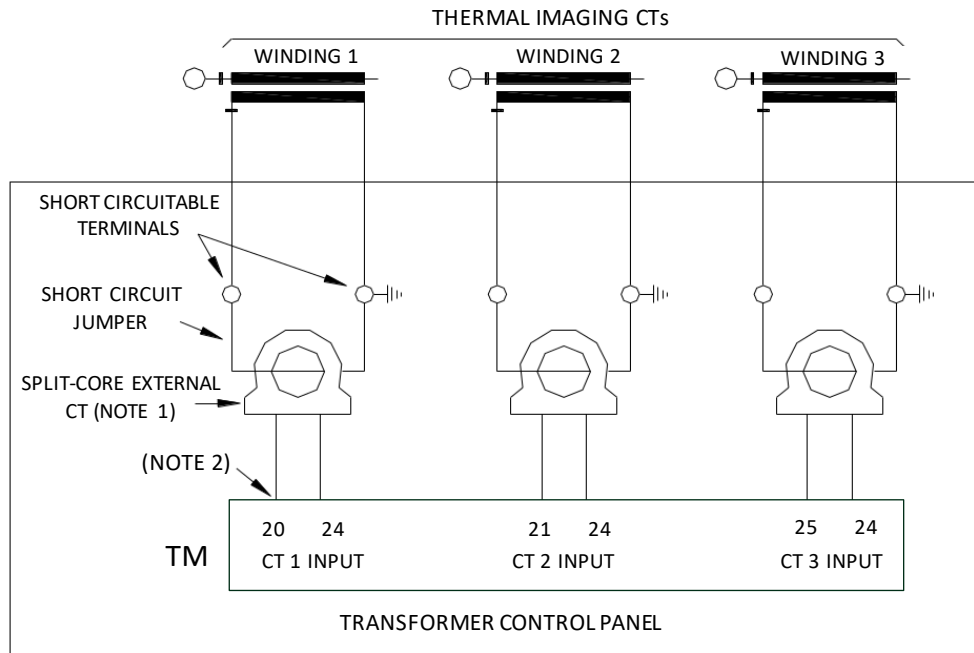

Figure 7 – Connections details of the current transformers in the Temperature Monitor

**Note 1:** Optional component provided by Treotech.

**Note 2:** Do not connect thermal imaging CTs directly to the temperature monitor. Risk of personal injury or equipment breakdown due to opening of the CT secondary.



### 3.2.7 Forced cooling control

The Temperature Monitor for Oil and Windings has two independent, potential-free NC contacts for controlling 1 to 2 forced cooling groups, as programmed by the user.

Group 1 is controlled by TM contacts 4 and 5, and group 2 is controlled by contacts 15 and 16, respectively. When energizing the Temperature Monitor, these contacts change state, returning to the rest position to turn on the cooling.

The forced cooling operation schedule is divided into 2 cooling stages. In each stage, its operating temperature is programmed (also the percentage of load for actuation, if the **PCOL - Pre-cooling** option is enabled) and the cooling groups that are registered and available for use by that stage. The following table exemplifies the programming of the cooling stages:

Table 4 - Programming the cooling stages

| Cooling stage | Activation temperature | Cooling groups |         |
|---------------|------------------------|----------------|---------|
|               |                        | Group 1        | Group 2 |
| <b>CST1</b>   | CS1T = 65 °C           | YES            | YES     |
| <b>CST2</b>   | CS2T = 70 °C           | YES            | YES     |

When the operating temperature of a given stage is reached, it will activate only one of its enrolled cooling groups (the groups enrolled in the stage are those selected as "YES"). The choice of which group to activate will be based on the groups' operating times: the one with the shortest operating time will be chosen. Similarly, when the temperature drops below the stage's deactivation value, it will turn off only one of the cooling groups that are connected and enrolled to it. The choice of which group to turn off will be based on the operating times of the groups: the one with the longest operating time will be chosen. In this way, the tendency will be for cooling groups to have equivalent working times, thus avoiding excessive wear on some groups more than others.

### 3.3 Mechanical installation

The Temperature Monitor for Oil and Windings must be installed and protected from the elements, either inside panels or sheltered in buildings. In either case, there must be an anti-condensation system.

The TM Temperature Monitor is suitable for built-in installation, and can be fixed, for example, to doors or front of panels. Fixing clips are supplied with the devices. The figure below shows the main dimensions of the equipment. Special attention must be paid to the thickness of the paint layers on the plate where the cutout is made, as in some cases, when high-thickness paint is used, the reduction in the cutout area can even prevent the insertion of the equipment. The connection terminals are installed on the rear of the TM, in 2 removable connectors, to facilitate connections. Cables from 0.5 to 2.5mm<sup>2</sup> can be used, bare or with “pin” (or “needle”) type terminals for removable connectors.

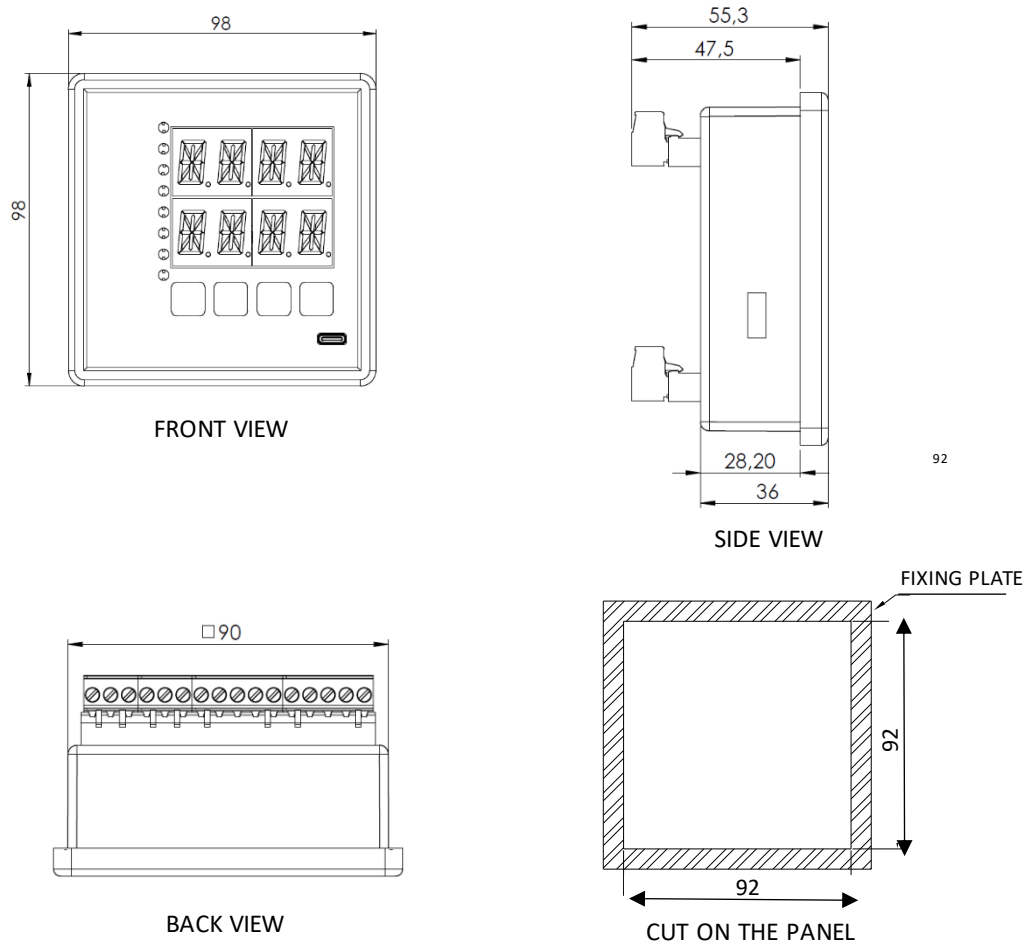

ALL DIMENSIONS IN mm

Figure 8 - TM dimensions

## 4 Operation

All operations on the Temperature Monitor for Oil and Windings are carried out via the keyboard on its front panel, with no external selector switches required. The temperatures of the oil, winding(s) and on-load tap changer (optional) will be indicated on the displays, and the occurrence of alarms, shutdowns and forced cooling operations will be indicated by the signaling LEDs.

### 4.1 Initial indications

During normal working mode, the Temperature Monitor will indicate the temperature of the oil and winding(s) connected to it.

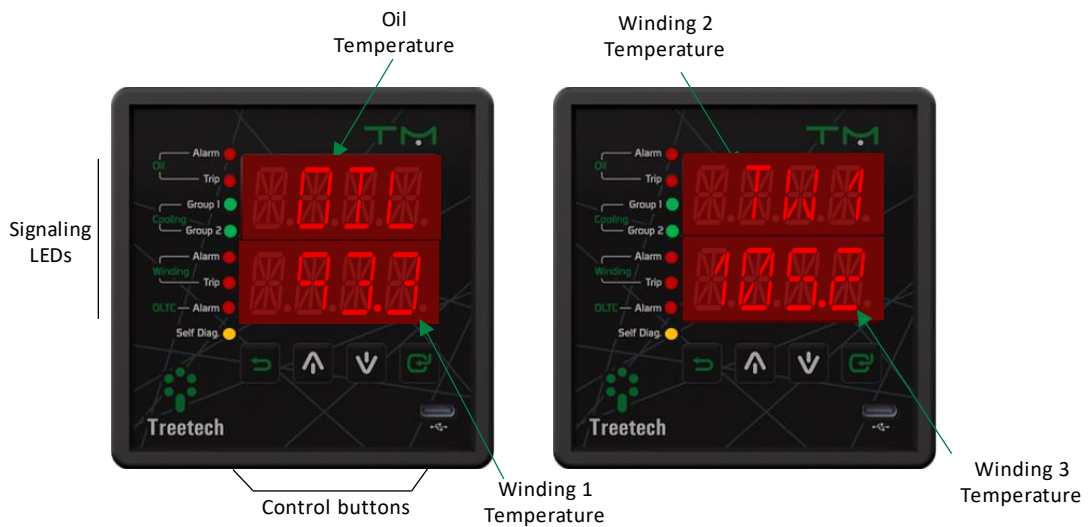

Figure 9 - TM indications

When the temperature value programmed for an event is reached, the corresponding LED will light up, also activating the output contact for this event.

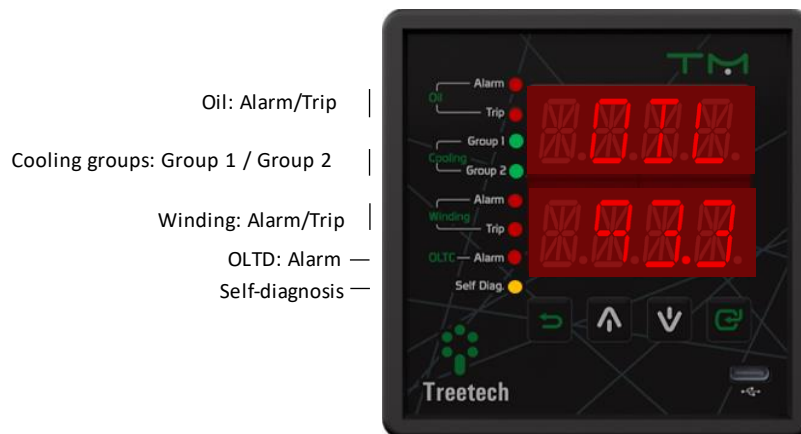





Figure 10 - TM signaling LEDs

If an anomaly occurs, the corresponding self-diagnosis code will be indicated on the displays.



## 4.2 Key functions

The keys have the following functions:









Table 5 - TM key functions

| Key  | Function   |
|--|--|
|   | <b>Programming Key:</b> On the measurement screens, it allows access to the password to enter the programming menu. In programming menus, abandon the current menu returning to the previous level menu. If activated while changing a parameter, returns to the previous level menu without saving the change made. |
|   | <b>Up Key:</b> Navigation between measurement screens and between menus and programming parameters. When editing a parameter, it increases the programmed value.   |
|   | <b>Down Key:</b> Navigation between measurement screens and between menus and programming parameters. When editing a parameter, it decreases the programmed value.   |
|  | <b>Enter Key:</b> Selects the menu and parameter option shown on the display, saves programmed values.   |



### 4.2.1 Accessing a submenu

When the submenu is displayed on the device screen, press the  key to proceed with programming. At any time press the  key to return to the main menu. Optional menus will only be shown if they are enabled.

After accessing the desired submenu:

- Use the keys  and  to navigate between submenu parameters;
- Press  to enter parameter editing;
- Press  and  to adjust the desired value for the parameter;
- Press  to save the change made to the parameter;
- Press  to return to the previous menu (if this key is pressed before the  in a parameter edit, it will not be saved).

## 4.3 Query screens

The Temperature Monitor for Oil and Windings provides various information for guidance regarding the working conditions of the transformer. This information is accessed through the keys  and  during normal work mode.

### 4.3.1 General screen

The following information will be indicated on the device displays. By pressing the key  we have the reverse order to that indicated below:

Table 6 - TM query screens

| TM query screens  |   |
|---|---|
| <p><b>Active self-diagnosis (SDG1)</b><br/>Indicates activation of self-diagnosis.</p>  |    |
| <p><b>Status (ALST)</b><br/>Indicates the equipment status.</p>   |    |
| <p><b>Oil (OIL)</b><br/>Indicates the current temperature of the transformer oil.</p>   |    |
| <p><b>Winding (W1)</b><br/>Indicates the measurement of the temperature of winding 1.</p>   |  |
| <p><b>Winding (W2)</b><br/>Indicates the measurement of the temperature of winding 2.<br/><b>Note:</b> This information will only be displayed by changing the parameter relating to the number of windings.</p>  |  |
| <p><b>Winding (W3)</b><br/>Indicates the measurement of the temperature of winding 3.<br/><b>Note:</b> This information will only be displayed by changing the parameter relating to the number of windings.</p>  |  |
| <p><b>Winding 1 loading (LDP1) (%)</b><br/>Displays the ongoing load on the transformer, indicating as a percentage of the rated current of the monitored winding.</p>  |  |
| <p><b>Winding 2 loading (LDP2) (%)</b><br/>Displays the ongoing load on the transformer, indicating as a percentage of the rated current of the monitored winding.<br/><b>Note:</b> This information will only be displayed by changing the parameter relating to the number of windings.</p> |  |



|  |   |
|--|---|
| <p><b>Winding 3 loading (LDP3) (%)</b><br/>Displays the ongoing load on the transformer, indicating as a percentage of the rated current of the monitored winding.</p> <p><b>Note:</b> This information will only be displayed by changing the parameter relating to the number of windings.</p> |  |
|--|---|

Table 7 - TEMP submenu information

| TEMP submenu information  |  |
|---|--|
| <p><b>TEMP submenu</b></p> <p>Use the arrow keys to continue browsing other information or press  on this screen to access the submenu and consult date and time data. Once inside, navigate using the arrow keys  and . To return to the previous level, press .</p> | <br> |
| <p><b>Maximum oil temperature (&gt;OIL):</b><br/>Indicates the maximum temperature reached by the transformer oil since the last time the marker was reset.</p> <p>To restart this record after consultation, simply press and hold the key  for 5 seconds.</p>  |    |
| <p><b>Maximum winding 1 temperature (&gt;W1):</b><br/>Indicates the maximum temperature reached in winding 1 of the transformer since the last time this marker was reset.</p> <p>To restart this record after consultation, simply press and hold the key  for 5 seconds.</p>   |   |
| <p><b>Maximum winding 2 temperature (&gt;W2)</b><br/>Indicates the maximum temperature reached in winding 2 of the transformer since the last time this marker was reset.</p> <p>To restart this record after consultation, simply press and hold the key  for 5 seconds.</p> <p><b>Note:</b> This information will only be displayed by changing the parameter relating to the number of windings.</p>  |   |
| <p><b>Maximum winding 3 temperature (&gt;W3)</b><br/>Indicates the maximum temperature reached in winding 3 of the transformer since the last time this marker was reset.</p> <p>To restart this record after consultation, simply press and hold the key  for 5 seconds.</p> <p><b>Note:</b> This information will only be displayed by changing the parameter relating to the number of windings.</p>  |   |



|  |  |
|--|--|
| <p><b>Cooling stages (CSTG)</b><br/>Indicates the number of cooling stages.</p>  |  |
| <p><b>Final gradient 1 (FTG1)</b><br/>Indicates what the final temperature gradient will be between the oil and winding 1 if the ongoing load continues.</p>   |  |
| <p><b>Final gradient 2 (FTG2)</b><br/>Indicates what the final temperature gradient will be between the oil and winding 2 if the ongoing load continues.</p> <p><b>Note:</b> This information will only be displayed by changing the parameter relating to the number of windings.</p> |  |
| <p><b>Final gradient 3 (FTG3)</b><br/>Indicates what the final temperature gradient will be between the oil and winding 3 if the ongoing load continues.</p> <p><b>Note:</b> This information will only be displayed by changing the parameter relating to the number of windings.</p> |  |
| <p><b>Winding 1 current in kA (W1KA)</b><br/>It is the current in winding 1 of the transformer where the temperature is being monitored, given in kA.</p>  |  |
| <p><b>Winding 2 current in kA (W2KA)</b><br/>It is the current in winding 2 of the transformer where the temperature is being monitored, given in kA.</p> <p><b>Note:</b> This information will only be displayed by changing the parameter relating to the number of windings.</p>    |  |
| <p><b>Winding 3 current in kA (W3KA)</b><br/>It is the current in winding 3 of the transformer where the temperature is being monitored, given in kA.</p> <p><b>Note:</b> This information will only be displayed by changing the parameter relating to the number of windings.</p>    |  |
| <p><b>Winding 1 secondary current (AMP1)</b><br/>This is the current flowing through winding 1, given in amps.</p>   |  |
| <p><b>Winding 2 secondary current (AMP2)</b><br/>This is the current flowing through winding 2, given in amps.</p> <p><b>Note:</b> This information will only be displayed by changing the parameter relating to the number of windings.</p>   |  |



















|   |   |
|---|---|
| <p><b>Winding 3 secondary current (AMP3)</b><br/>This is the current flowing through winding 3, given in amps.</p> <p><b>Note:</b> This information will only be displayed by changing the parameter relating to the number of windings.</p>  |    |
| <p><b>Measurement of temperature sensor 1 connected to TM (PT1)</b><br/>It is the temperature being measured through temperature sensor 1, given in °C.</p>   |    |
| <p><b>Measurement of temperature sensor 2 connected to TM (PT2)</b><br/>It is the temperature being measured through temperature sensor 2, given in °C.</p>   |    |
| <p><b>Maximum temperature of temperature sensor 1 connected to the TM (&gt;PT1)</b><br/>Shows the maximum temperature measured by the Pt100Ω sensor since the last time this marker was reset.</p> <p>To restart this record after consultation, simply press and hold the key  for 5 seconds.</p>   |    |
| <p><b>Maximum temperature of temperature sensor 2 connected to the TM (&gt;PT2)</b><br/>Shows the maximum temperature measured by the Pt100Ω sensor since the last time this marker was reset.</p> <p>To restart this record after consultation, simply press and hold the key  for 5 seconds.</p> |  |



Table 8 - CLK submenu information

| <b>CLK submenu information</b>   |  |
|--|--|
| <p><b>CLK submenu</b></p> <p>Use the arrow keys to continue browsing other information or press  on this screen to access the submenu and consult date and time data. Once inside, navigate using the arrow keys  and . To return to the previous level, press .</p> | <br> |
| <p><b>Month indication (MNTH)</b><br/>Indication of the month in the device's internal calendar.</p>   |   |
| <p><b>Day indication (DAY)</b><br/>Indication of the day on the device's internal calendar.</p>  |   |



|  |   |
|--|---|
| <p><b>Year indication (YEAR)</b><br/>Indication of the year on the device's internal calendar.</p>   |  |
| <p><b>Hour indication (HOUR)</b><br/>Indication of the hour on the device's internal clock.</p>      |  |
| <p><b>Minutes indication (MIN)</b><br/>Indication of the minutes on the device's internal clock.</p> |  |

## 4.4 Equipment information

By simultaneously pressing the keys  and  it is possible to consult equipment information, the following data will be displayed on the equipment display: name, firmware version (FW), release, bootloader (BL), bootloader release, functionalities, serial number 1 and 2.

### Equipment name:

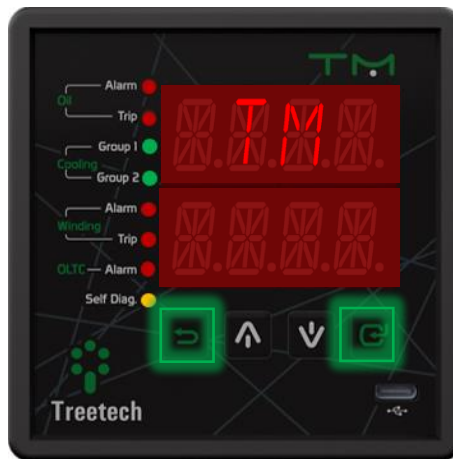

Figure 11 - Command to access equipment information

### Firmware version:



Figure 12 - Display indicating firmware version

**Firmware release:**



Figure 13 - Display indicating firmware release version

**Bootloader version:**



Figure 14 - Display indicating bootloader version

**Bootloader release:**



Figure 15 - Display indicating bootloader release version

## Functionalities



Figure 16 - Display indicating the number of windings

### Serial number:

The Serial Number is divided into part 1 and part 2, reading the complete serial number is done as follows:

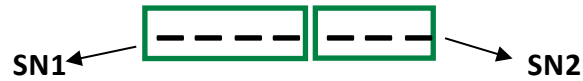

### Example:

If the serial number is 1234567, **SN1** will be 1234 and **SN2** will be 567.





Figure 17 - Display indicating part 1 and part 2 of the serial number

## 5 Parameterization



To guarantee the correct operation of the system, several parameters must be adjusted in the TM that will provide the equipment with the information necessary for its operation. Adjustments can be made using the front keyboard, with the help of the display, or the rear, using the RS-485 communication ports, available to the user on the device's rear panel. Programmable parameters are organized into menus with password-protected access. In the main menu, the user will have access to programming submenus, where they can navigate and adjust values according to the characteristics of the transformer and user needs.

### 5.1 Access to programming menus

To access the Monitor TM programming menu, follow the procedure below:

- 1) On the temperature display screen, press  and hold the key  for 5 seconds.
- 2) The password screen will be displayed.



- 3) Use the keys  and  to adjust the password (range = 0 to 9999). If the initial indication is 4210, then the password will be 0, which is the original factory value.
- 4) After setting the password, press and release the key  to enter the programming menu.
- 5) Main menu screen, where you can navigate to programming submenus.





## 5.2 Parameter map

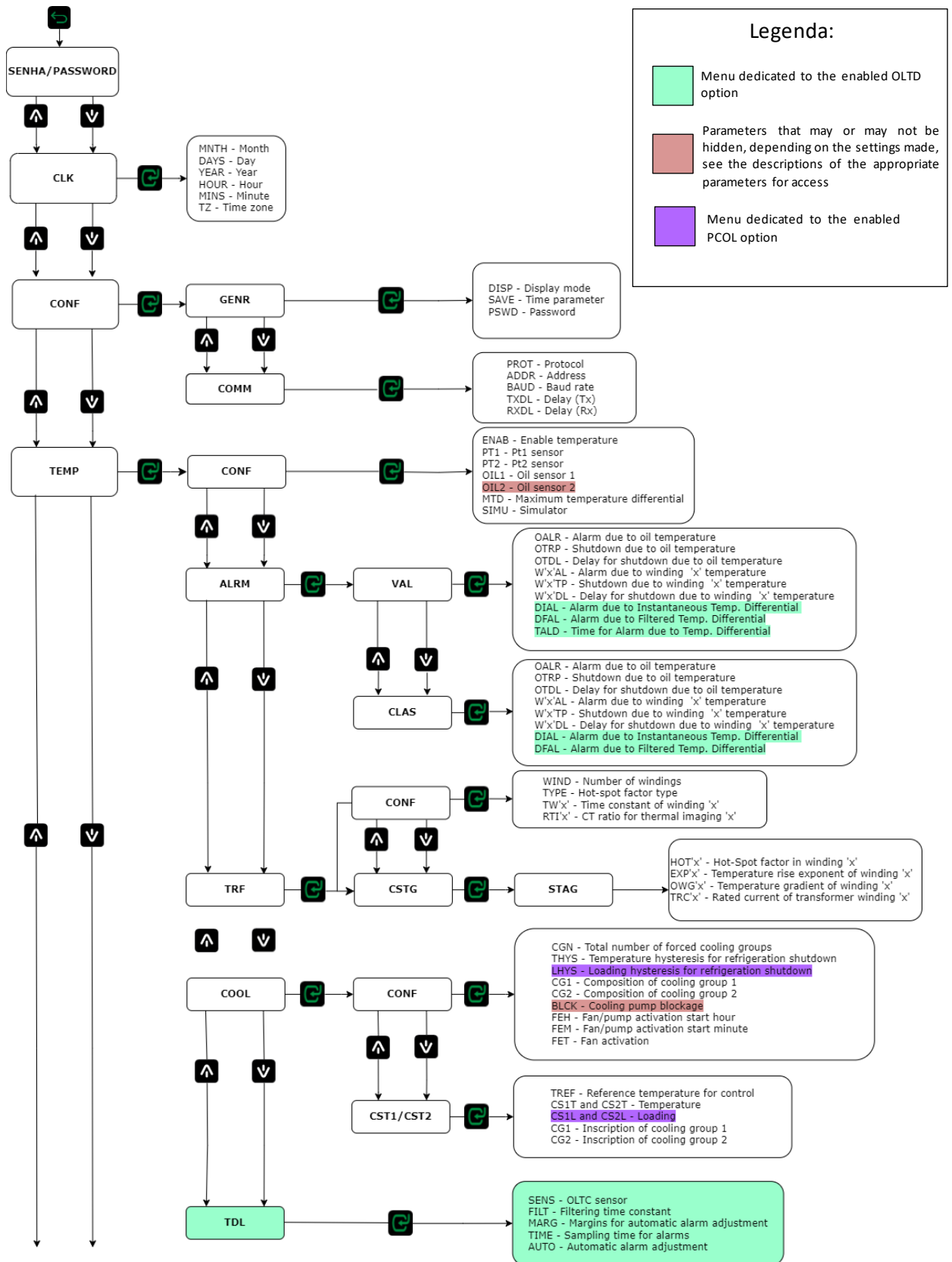

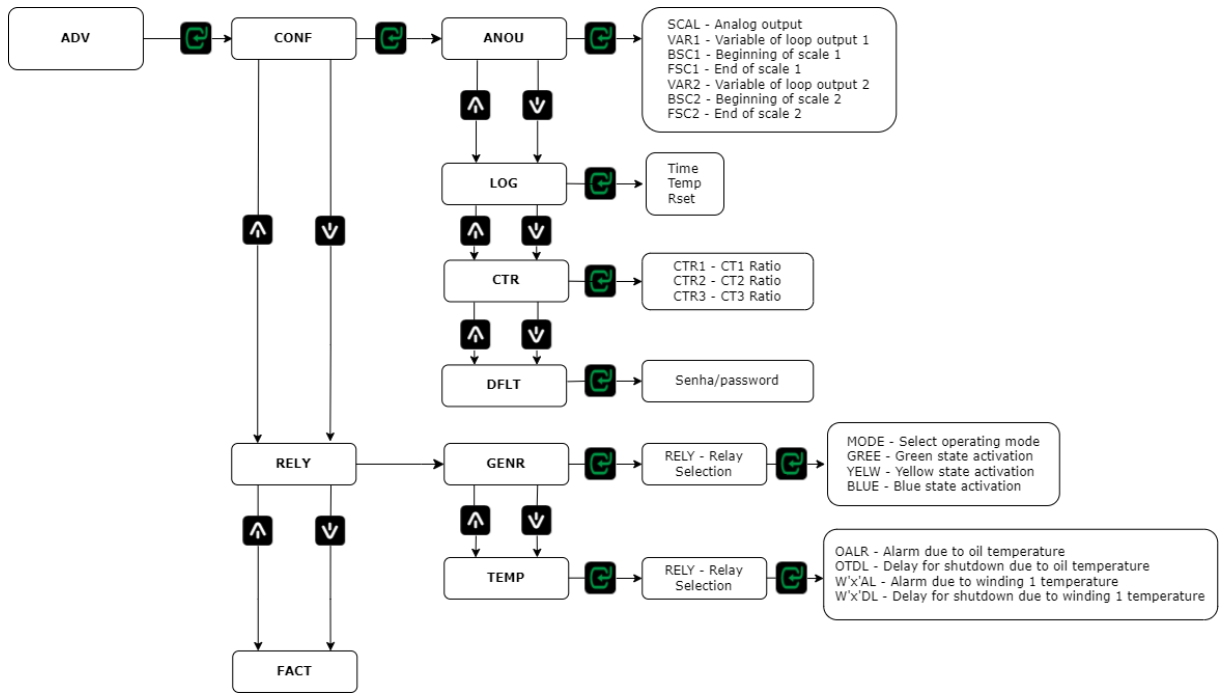

Figure 18 - Menu access structure

## 5.3 CLK Menu

It allows you to adjust the device's clock and calendar.



### MNTH - Month

Adjusting the current month in the equipment calendar.



**Adjustment range:** 1 to 12, in steps of 1 month.

**Standard value:** 0.

### DAYS - Day

Adjusting the current day in the equipment calendar.



**Adjustment range:** 1 to 31, in steps of 1 day.

**Standard value:** 0.

### YEAR - Year

Adjusting the current year in the equipment calendar.



**Adjustment range:** 0 to 99, in steps of 1 year.

**Standard value:** 0.

### HOUR - Hora

Adjusting the current time on the equipment clock.



**Adjustment range:** 0 to 23, in steps of 1 hour.

**Standard value:** 0.

### MINS - Minuto

Adjusting the minutes on the equipment clock.



**Adjustment range:** 0 to 59, in steps of 1 minute.

**Standard value:** 0.

### TZ - Fuso Horário

Adjusting the time zone, in hours, on the equipment clock.



**Adjustment range:** -12 to +12, in steps of 1 hour.

**Standard value:** -3.



## 5.4 CONF Menu

It allows access to parameters relating to the basic usability settings of the TM.



### 5.4.1 GENR Submenu

This submenu allows you to make general TM settings.

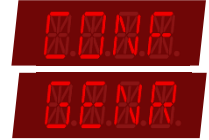

#### DISP - Display

Temperature display mode on the TM display in normal operation.



#### Adjustment range:

- **SCRL** = Alternating display, the TM displays each of the measured temperatures for 10 seconds, cyclically;
- **STAY** = The display remains fixed on the last sensor viewed on the front;

**Standard value:** SCRL.

#### SCRN - Default screen



This screen will only be displayed when enabling STAY mode on the TM display.

#### Adjustment range:

- LD3 (% load 3);
- LD2 (% load 2);
- LD1 (% load 1);
- W3 (Winding 3 temperature);
- W2 (Winding 2 temperature);
- W1 (Winding 1 temperature);
- OIL (Oil temperature);
- ALST (Alarm status);
- NONE.

**Standard value:** ALST.

**Note:** It will only display the LD2, LD3, W2, W3 screens once it is configured for 2 or 3 windings in the TRF submenu, otherwise these will remain hidden.

#### SAVE



Time parameter to activate the screen saver.

**Adjustment range:** 1 to 15, in steps of 1 minute.

**Standard value:** 5.

### PSWD - Password



Here the user can change the password to access the TM configuration menu.

**Adjustment range:** 0 to 8191.

**Standard value:** 0.

### 5.4.2 COMM Submenu - Communication



It allows access to parameters relating to serial communication.



**Adjustment range:**

- U1 (RS-485 1);
- U2 (RS-485 2);
- USB (Front USB Type-C).

**Standard value:** U1.

### PROT – Serial communication protocol



Select the communication protocol to be used Modbus® RTU (Mdb) and DNP3 (DNP3).

**Note:** The equipment supports that only one of the three ports is configured in DNP3.

**Adjustment range:**

- Mdb = Modbus® RTU;
- DNP = DNP3;
- NONE.

**Standard value:** MDB.

### ADDR - Address



Selection of the device address in the communication network, used for data acquisition.

**Note:** For USB-C port it has a fixed address 247.

If the Modbus® RTU protocol is selected in the **PROT** parameter.

**Adjustment range:** 1 to 247.

**Standard value:** 247.

### DNP3 Address Presentation on Display



The DNP3 address will be considered as follows:

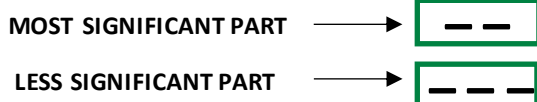

When the value is above 9999, the most significant part will be available on the top two displays, and the least significant part on the bottom displays.

Suppose the address is 65519. In this case, the most significant part would be 65 and the least significant part would be 519.

**Adjustment range:** 0 to 65519, in steps of 1.

**Standard value:** 247.

### BAUD – Transmission speed



Selecting data transmission speed.

**Adjustment range:**

- 4.8 kbps;
- 9.6 kbps;
- 19.2 kbps;
- 38.4 kbps;
- 57.6 kbps;
- 115.2 kbps.

**Standard value:** 9.6 kbps.

### TXDL – Tx Delay



Parameter responsible for defining the interframe waiting time for data transmission, that is, it is the waiting time between one transmission and another.

**Adjustment range:** 5 to 500, in steps of 1 millisecond.

**Standard value:** 25 ms.

### RXDL – Rx Delay



Parameter responsible for defining the interframe waiting time for receiving data, that is, it is the waiting time for receiving a data packet.

**Adjustment range:** 5 to 500, in steps of 1 millisecond.

**Standard value:** 5 ms.



## 5.5 TEMP Menu

It allows access to submenus relating to temperature measurement, alarms and forced cooling groups.



### 5.5.1 CONF Submenu - Configuration

It allows configuration of temperature sensors.



#### ENAB – Enable temperature

Enables parameters and measurements related to temperature readings on the equipment's query screens.



**Adjustment range:** YES, NO.

**Standard value:** YES.

#### PT1 – Pt1 sensor

It enables RTD1 sensor measurements.



**Adjustment range:**

- 1X3 = 1 PT100 3-wire sensor for oil temperature;
- OFF.

**Standard value:** 1X3.

#### PT2 – Pt2 sensor

It enables RTD2 sensor measurements.



**Adjustment range:**

- 1X3 = 1 PT100 3-wire sensor for oil temperature;
- OFF.

**Standard value:** OFF.

#### OIL1 – Oil sensor 1

Selecting which sensor will read the oil temperature.



**Adjustment range:** PT1, PT2 and OFF.

**Standard value:** PT1.

#### OIL2 – Oil sensor 2

Selecting which sensor will take the second oil temperature reading.



**Note:** It is necessary to have two sensors enabled to access this parameter, otherwise it will remain hidden.

**Adjustment range:** PT2 and OFF.

**Standard value:** OFF.

### MTD – Maximum temperature differential

Parameter of maximum temperature difference allowed between redundant sensors.

**Adjustment range:** 1.0 to 6.0.

**Standard value:** 4.0.

### SIMU – Simulator

In the case of any test or experiment that involves connecting a temperature sensor simulator to the TM, please indicate which input will be used for this purpose.

**Adjustment range:** OFF, PT1 and PT2 (if enabled).

**Standard value:** OFF.

## 5.5.2 ALRM Submenu - Alarms

It contains parameters related to the classification and values of alarm triggers.

### 5.5.2.1 VAL – Value Submenu

It contains parameters to select temperature alarm trigger values.

### OALR – Alarm due to oil temperature

It determines the alarm value for transformer oil temperature. The alarm is only deactivated if the temperature drops 1°C or more below the trigger value.

**Adjustment range:** -55 to 20, in steps of 1°C.

**Standard value:** 95 °C.

### OTRP – Shutdown due to oil temperature

It determines the value for a shutdown due to oil temperature. Once triggered, the alarm is only deactivated if the temperature drops 1°C or more below the trigger value. It can also be used as a second level alarm if automatic transformer shutdown is not desired.

**Adjustment range:** -55 to 200, in steps of 1°C.

**Standard value:** 105 °C.

### OTDL – Delay for shutdown due to oil temperature

It allows the user to insert a delay between the moment the oil temperature reaches the shutdown value and the instant the shutdown signal and associated output relays are activated.

**Adjustment range:** 0 to 20.0, in steps of 0.1 minute.

**Standard value:** 20 minutes.





This submenu contains settings for windings 1, 2 and 3. These settings are repeated for all of them.

The 'x' indicates the winding number.

**Example:** (W1AL), (W2AL) and (W3AL).

### W'x'AL – Alarm due to winding 'x' temperature



It determines the value for alarm due to the temperature of the transformer winding 'x'. Once triggered, the alarm is only deactivated if the temperature drops 1°C or more below the trigger value.

**Adjustment range:** -55 to 20, in steps of 1°C.

**Standard value:** 105 °C.

### W'x'TP – Shutdown due to winding 'x' temperature



It determines the value for shutdown due to transformer winding 'x' temperature. Once triggered, the alarm is only deactivated if the temperature drops 1°C or more below the trigger value. It can also be used as a second level alarm if automatic transformer shutdown is not desired.

**Adjustment range:** -55 to 200, in steps of 1°C.

**Standard value:** 120 °C.

### W'x'DL – Delay for shutdown due to winding 'x' temperature



It allows you to insert a delay between the moment the winding 'x' temperature reaches the shutdown value and the instant the shutdown signal and associated output relays are effectively activated.

**Adjustment range:** 0 to 20.0, in steps of 0.1 minute.

**Standard value:** 20 minutes.

### 5.5.2.2 CLAS – Classification Submenu



Not all alarms have the same degree of severity, nor should they be responded to with the same approach. According to your convenience, in this submenu the user can classify the different alarms into three different categories.

The blue category has a low priority and should be used mainly for warnings, the yellow category should be used when a serious problem is detected and the red category when the situation is urgent.



### OALR – Alarm due to oil temperature

Classify this alarm into one of the categories listed in the adjustment range.

**Adjustment range:** RED, YELW (yellow), BLUE.

**Standard value:** RED.

### OTRP – Shutdown due to oil temperature



Classify this alarm into one of the categories listed in the adjustment range.

**Adjustment range:** RED, YELW (yellow), BLUE.

**Standard value:** RED.

### OTDL – Delay for shutdown due to oil temperature



Classify this alarm into one of the categories listed in the adjustment range.

**Adjustment range:** RED, YELW (yellow), BLUE.

**Standard value:** RED.



The following parameters contain settings for windings 1, 2 and 3. These settings are repeated for all of them.

The 'x' indicates the winding number.

**Example:** (W1AL), (W2AL) and (W3AL).

### W'x'AL - Alarm due to winding 'x' temperature



Classify this alarm into one of the categories listed in the adjustment range.

**Adjustment range:** RED, YELW (yellow), BLUE.

**Standard value:** RED.

### W'x'TP - Shutdown due to winding 'x' temperature



Classify this alarm into one of the categories listed in the adjustment range.

**Adjustment range:** RED, YELW (yellow), BLUE.

**Standard value:** RED.

### W'x'DL - Delay for shutdown due to winding 'x' temperature



Classify this alarm into one of the categories listed in the adjustment range.

**Adjustment range:** RED, YELW (yellow), BLUE.

**Standard value:** RED.

## 5.5.3 TRF Submenu - Transformer



The transformer parameterization submenu allows access to general transformer characteristics and cooling stages.





### 5.5.3.1 CONF – Configuration Submenu

It contains parameters to configure the basic characteristics of the transformer.



#### WIND – Number of windings

Allows the user to adjust the value according to the number of transformer windings.



**Adjustment range:** 1 to 3.

**Standard value:** 1.

#### TYPE – Hot-spot factor type

Choose the standard whose methodology will be adopted to calculate the temperature of the windings, especially with regard to the hot-spot.



**Adjustment range:** ANSI and IEC.

- ANSI IEEE C57.91/2011; ABNT NBR 5416/1997;
- IEC 60076-7/2018; ABNT NBR 5356-7/2017.

**Standard value:** ANSI.



The following parameters contain settings for windings and CTs 1 to 3. These settings are repeated for all of them.

The 'x' indicates the winding number and CT.

**Example:** (TW1), (TW2) and (TW3).

#### TW'x' - Time constant of thermal inertia of winding 'x'

It is the time constant in seconds, related to the thermal inertia of the transformer winding.



This parameter can be measured during the heating test or calculated by the transformer manufacturer. If it is not possible to obtain it in one of these two ways, the typical value of 300s can be adopted.

**Adjustment range:** 72 to 999 seconds.

**Standard value:** 300 seconds.

#### RTI'x' – CT ratio for thermal imaging 'x'

Parameterize the transformation ratio of the thermal image CT of winding 'x'.



$$CT\ Ratio = \frac{CT\ primary\ current}{CT\ secondary\ current}$$

**Adjustment range:** 1 to 9999.

**Standard value:** 500.



### 5.5.3.2 CSTG – Cooling stages

Contains parameters for each active cooling stage, parameters relating to the calculation of winding temperatures and hot-spot.



#### 5.5.3.2.1 STAG – Stage number

Select the number of stages.



##### Adjustment range:

- **0:** Configures parameters for calculating temperature rises when no forced cooling stage is activated;
- **1:** Configures parameters for calculating temperature rises when the first stage of forced cooling is in operation;
- **2:** Configures parameters for calculating temperature rises when the second stage of forced cooling is in operation;
- **ALL:** Configures simultaneously, with the same values, the calculation parameters for all previous situations. It should be used when there are no differences in temperature elevations.

**Standard value:** 0.



The following parameters contain settings for windings 1, 2 and 3. These settings are repeated for all of them.

The 'x' indicates the winding number.

**Example:** (HOT1), (HOT2) and (HOT3).

### HOT'x' – Hot-spot factor in winding 'x'



Configure the hot-spot factor according to the model adopted by the following standards:

- **HS+:** ANSI IEEE C57.91-1995 and ABNT NBR 5416 (1997);
- **HS\*:** IEC 60076-7 and ABNT NBR 5356-7 (2017).

In the first case (HS+), it is the difference between the temperature of the hottest point (hot-spot) and the average temperature of the winding.

According to the IEC standard (HS\*), it is the relationship between the temperature rise of the hottest point over the top oil temperature and the mean winding temperature rise over the mean oil temperature.

**Adjustment range:** 0.00 to 20.00.

**Standard value:** 1.00.

### EXP'x' – Temperature rise exponent of winding 'x'



Exponent used in calculating winding temperature rise as a function of copper losses, defined by the type of transformer oil circulation.

The value selection is flexible, however, some notable numbers stand out:

Table 9 - IEC winding exponent

| Winding exponent — IEC 60076-7 (2005) and ABNT NBR 5356 – 7 (2017) standards |   |   |
|--|---|---|
| Number   | Applicability                             | Description   |
| 1.3  | Large and medium-sized power transformers | Transformers cooled by natural or forced oil circulation (ONAN, ONAF, OFAF, OFWF) |
| 1.6  | Distribution transformers                 | Transformers cooled by natural or forced oil circulation (ONAN, ONAF, OFAF, OFWF) |
| 2.0  | Large and medium-sized power transformers | Transformers cooled by oil-directed circulation (ODAF, ODWF)                      |

Table 10 - IEEE winding exponent

| Winding exponent — ABNT NBR 5416 (1997) and IEEE C57.91 (2011) standards |   |
|--|---|
| Number   | Description   |
| 1.6  | Transformers cooled by natural or forced oil circulation (ONAN, ONAF, OFAF, OFWF) |
| 2.0  | Transformers cooling by oil-directed circulation (ODAF, ODWF)                     |

**Adjustment range:** 0.0 to 4.0.

**Standard value:** 1.3.

### OWG'x' – Temperature gradient of winding 'x'



Configure the OWG (oil-winding temperature gradient), defined as follows:

- **IEC 60076-7 / NBR 5356–7:** the difference between the average winding temperature and the average oil temperature, after thermodynamic stabilization of the transformer at rated load;
- **NBR 5416 / IEEE C57.91-1995:** the increase in the average winding temperature in relation to the top oil temperature, after thermodynamic stabilization of the transformer at nominal load.

This parameter is generally obtained by the transformer/reactor manufacturer during heating tests or by calculation.

**Adjustment range:** 0 to 50, in 0.1°C steps.

**Standard value:** 10 °C.



### TRC'x' – Rated current of transformer winding 'x'

Rated current of the transformer winding where the temperature is being determined.

**Adjustment range:** 0.001 to 99.99 kA, in steps of 0.001 kA.

**Standard value:** 1.670 kA.

### 5.5.4 COOL Submenu - Forced cooling

The submenu has information regarding the operation of forced refrigeration and is subdivided into three other menus.

#### 5.5.4.1 CONF Submenu - Configuration

It contains parameters to adjust the general cooling characteristics of the transformer.

#### CGN – Total number of forced cooling groups

Allows the user to enable the number of cooling groups that will be used.

**Adjustment range:** 1 to 2.

**Standard value:** 2.

#### THYS – Temperature hysteresis for refrigeration shutdown

Temperature reduction value, below the starting temperature of the cooling stage, to turn off the fans/pumps, to prevent them from being switched on and off repeatedly with small temperature variations.

**Adjustment range:** 0 to 30 °C, in steps of 1°C.

**Standard value:** 5 °C.

#### LHYS – Loading hysteresis for refrigeration shutdown

Reduction value of the loading percentage, below the starting percentage of the cooling stage, to turn off the fans/pumps, to prevent them from being switched on and off repeatedly with small load variations.

**Note:** This parameter belongs to the optional **PCOL — Pre-cooling**.

**Adjustment range:** 0 to 9, in steps of 1%.

**Standard value:** 5%.

#### CG1 – Composition of cooling group 1

It informs whether cooling group 1 has oil pumps or just fans.

**Adjustment range:** FAN and PUMP.

**Standard value:** FAN.

### CG2 – Composition of cooling group 2

It informs whether cooling group 2 has oil pumps or just fans.



**Adjustment range:** FAN and PUMP.

**Standard value:** FAN.

### BLCK – Cooling pump blockage

Temperature parameter for cooling pump blocking.



**Note:** This parameter will only be displayed if pump mode is enabled in the composition of cooling group 1 or 2.

**Adjustment range:** -55 to 200, in steps of 1°C.

**Standard value:** -25 °C.

### FEH – Fan/pump activation start hour

Adjustment of the hour at which the forced cooling groups will be switched on for the daily activation of fans and/or pumps.



**Adjustment range:** 0 to 23, in steps of 1 hour.

**Standard value:** 22 hours.

### FEM – Fan/pump activation start minute

Adjustment of the minute (in addition to the hour selected in the previous parameter) in which the forced cooling groups will be switched on for the daily activation of fans and/or pumps.



**Adjustment range:** 0 to 59, in steps of 1 minute.

**Standard value:** 30 minutes.

### FET – Duration of the ventilators activation period

Adjustment of the total daily time that forced cooling groups must remain activated to operate fans or pumps.



If it is necessary to deactivate the daily cooling activation function, simply program this parameter to zero.

**Adjustment range:** 0 to 999, in steps of 1 minute.

**Standard value:** 45 minutes.

### 5.5.4.2 CST1 and CST2 Submenu – Forced cooling stage 1 and 2

The two submenus contain parameters for adjusting specific characteristics of the first and second forced cooling stages.



Cooling stages describe how the active cooling groups should behave and what should be in each temperature or transformer load situation. In these submenus, distribute and configure the operation of the cooling groups in two distinct cooling stages.

### TREF – Reference temperature for control



Select, in automatic mode, the cooling stage that should be controlled by the temperature of the top of the oil or the windings.

**Adjustment range:** WIND (winding), OIL.

**Standard value:** WIND (winding).

### CS1T and CS2T – Temperature to activate stage ‘x’



Temperature for activating forced cooling stage ‘x’.

When the cooling stage is activated, one of the cooling groups selected as “YES” in the “CG1” and “CG2” parameters will be turned on, with priority being given to activating the group that has the shortest operating time.

**Adjustment range:** -55 to 200, in steps of 1°C.

**Standard value:** Stage 1 = 65 °C, stage 2 = 70 °C.

### CS1L and CS2L – Loading to activate stage ‘x’



Percentage loading of the load to activate the forced cooling stage ‘x’.

When the cooling stage is activated, one of the cooling groups selected as “YES” in the “CG1” and “CG2” parameters will be turned on, with priority being given to activating the group that has the shortest operating time.

**Note:** This parameter belongs to the optional **PCOL – Pre-Cooling**.

**Adjustment range:** 50 to 200, in steps of 1%.

**Standard value:** Stage 1 = 65%, stage 2 = 70%.

### CG1 and CG2 - Inscription of cooling groups 1 and 2 in the Forced Cooling stage ‘x’



Selects whether or not cooling group 1 or 2 is included in stage 'x' of forced cooling, that is, whether it can be used by the cooling stage when its temperature or percentage of drive load is reached.

**Adjustment range:** YES, NO.

**Standard value:** YES.

## 5.5.5 TDL Submenu - Temperature differential (Optional)



In this submenu, configure the characteristics of monitoring the temperature differential between the transformer and the switch.







This submenu will only be available if the optional **OLTD — OLTC Temperature Differential** is enabled.

### SENS – OLTC sensor



Indicate which sensor will measure the temperature of the tap changer.

Only those who are not already assigned to other roles will appear as an option.

**Note:** Only those that are not already assigned to other functions will appear as an option, and can be adjusted in section 5.5.1 of the CONF submenu of this manual.

**Adjustment range:** OFF, PT1 (RTD 1 sensor) and PT2 (RTD 2 sensor).

**Standard value:** OFF.

### FILT – Filtering time constant



Time constant for filtering the tap changer temperature differential to form the filtered differential.

**Adjustment range:** 0 to 720, in steps of 1 minute.

**Standard value:** 180 minutes.

### MARG – Margins for automatic alarm adjustment



Safety margin added to the largest difference recorded between the tap changer and transformer temperatures during the automatic learning period. Used to set the alarm threshold.

**Adjustment range:** 1 to 10, in steps of 1°C.

**Standard value:** 5°C.

### TIME – Sampling time for alarms



Total sampling time for automatic adjustment of instantaneous and filtered temperature differential alarms.

**Adjustment range:** 1 to 720, in steps of 1 minute.

**Standard value:** 336 minutes.

### AUTO – Automatic alarm adjustment



Allows the user to start or stop the automatic adjustment process of alarms due to instantaneous and filtered temperature differentials.

**Adjustment range:** YES, NO.

**Standard value:** NO.

## 5.6 ADV Menu

This menu has five submenus for advanced configurations, related to: analog output adjustments in mA, relays and factory menu.



### 5.6.1 CONF Submenu

It has advanced equipment settings, such as mA output adjustments, mass memory, CT ratio and reset of TM parameters.



#### 5.6.1.1 ANOU – mA output submenu

It contains analog output configuration parameters.

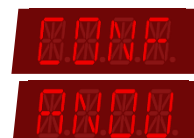

#### SCAL - Analog output range (mA)

Sets current loop output range for remote indication.



#### Adjustment range:

- 0...1 (mA);
- 0...5 (mA);
- 0...10 (mA);
- 0...20 (mA);
- 4...20 (mA).

**Standard value:** 0... 20 mA.



The following parameters contain the settings for analog outputs 1 and 2. These settings are repeated for all of them.  
The 'x' indicates the output number.  
**Example:** VAR1, VAR2.

#### VAR'x' – Variable of current loop analog output 'x'



Select which information you want to transmit via the selected analog output.

#### Adjustment range:

- |                         |                       |
|-------------------------|-----------------------|
| • OIL;                  | • PT2 (RTD 2 sensor); |
| • W1 (winding 1);       | • CT1 (CT 1 current); |
| • W2 (winding 2);       | • CT2 (CT 2 current); |
| • W3 (winding 3);       | • CT3 (CT 3 current); |
| • WH (hottest winding); | • NONE.               |
| • PT1 (RTD 1 sensor);   |                       |

**Standard value:** OIL.

**BSC'x'** - Value measured at the beginning of scale of the mA output 'x'

Define the correspondence between the initial current on the mA scale and the first value on the scale of the measured quantity.

**Adjustment range:** -99.9 to 999.9.

**Standard value:** 0.0.

**FSC'x'** - Value measured at the full scale of the mA output 'x'

Define the correspondence between the final current on the mA scale and the last value on the scale of the measured quantity.

**Adjustment range:** -99.9 to 999.9.

**Standard value:** 150.0

**5.6.1.2 LOG Submenu**

It allows access to all parameters relating to the mass memory log.



The Mass Memory log records temperature changes, alarm triggers, shutdowns and other information with date and event.

**TIME - Recording interval**

Selects the time between when recordings will be made. The TM has 23,000 positions for recording variables. To find out how long the memory will take to be completely occupied, just do:

$$\text{Total time} = \text{positions [recordings]} \cdot \text{interval} \left[ \frac{\text{min}}{\text{record.}} \right] = 32767 \cdot \text{interval [min]}$$

The default value for this parameterization is 60 min, this would give:

$$\text{Total time} = 32767 \cdot 60 = 1966020 \text{ minutes} \cong 1365 \text{ days}$$

When the maximum number of records is reached, the oldest records are overwritten by the new ones.

**Adjustment range:** 1 to 9999, in steps of 1 minute.

**Standard value:** 60 minutes.

**TEMP – Temperature variation for recording**

Regardless of the recording interval, if the transformer oil temperature varies above that programmed in this item, a new record will be made in the log of all variables.

**Adjustment range:** 1 to 20, in steps of 1°C.

**Standard value:** 5 °C.



### RSET – Recording reset

“YES” must be selected if the intention is to erase the memory contents so far. Otherwise keep “NO” selected.



**Adjustment range:** YES, NO.

**Standard value:** NO.

### 5.6.1.3 CTR – CT Ratio

In this submenu, parameters will be available for configuring the transformation ratio of the sectional window external CT (clip-on CT).



This submenu contains the transformation ratio settings for CTs 1 to 3.

The 'x' indicates the CT number.

**Example:** CTR1, CTR2 and CTR3.

### CTR'x' – CT 'x' ratio

Enter the value of the transformation ratio of the external sectional window CT (the accessory sold by Treotech has a ratio of 3100).



**Adjustment range:** 1 to 10000.

**Standard value:** 3000.

### 5.6.1.4 Default settings

It has a parameter that allows the user to restore the equipment to factory settings.



### PSWD – Password

It changes the default configuration menu access password.



**Adjustment range:** 0 to 8191.

**Standard value:** 0.

### DFLT – Default settings

When changing the password, “YES” must be selected if the intention is to restore factory settings. Otherwise keep “NO” selected.



Then press the button , all equipment parameters will return to factory default values.

**Adjustment range:** YES or NO.

**Standard value:** NO.

## 5.6.2 RELY Submenu

This menu allows access to all parameters relating to the operation of the TM output relays.



### 5.6.2.1 GENR – General submenu

It allows access to parameters to configure relays for general functions.



#### RL'x' – Relay selection

Choose which relay is to be parameterized.



**Adjustment range:** 5, 6 or 7.

**Standard value:** 5.

#### MODE - Operating mode

Contacts 5, 6, 7 can be configured to operate in normal mode (**NORM**) or inverted mode (**INVE**).



**Adjustment range:**

- **NORM (normal):** The relay changes state when activated.
- **INVE (inverted):** When energizing the equipment, the contact will change state. When the relay is activated, the contacts will return to the rest state.

**Standard value:** NORM (normal).

#### GREE – Activation in green state

It activates the relay when the general alarm status is green, that is, when there is no abnormality detected.



**Adjustment range:** YES, NO.

**Standard value:** NO.

#### YELW – Activation in yellow state

Activates the relay when the general alarm status is yellow.



**Adjustment range:** YES, NO.

**Standard value:** NO.

#### BLUE - Activation in blue state

Activates the relay when the general alarm status is blue.



**Adjustment range:** YES, NO.

**Standard value:** NO.



### RED – Activation in red state

Activates the relay when the general alarm status is red.



**Adjustment range:** YES, NO.

**Standard value:** NO.

**Note:** There are many more alarms than there are relays to signal them, but a relay can be activated for more than one reason and this allows you to know the status of the alarms by category.

### 5.6.2.2 TEMP – Temperature submenu

It contains relay configurations for functions related to temperature monitoring.



### RL'x' – Relay selection

Choose which relay is to be parameterized.



**Adjustment range:** 5, 6 or 7.

**Standard value:** 5.

### OALR – Association of the relay with the alarm due to oil temperature

It activates the relay depending on the oil temperature alarm.



**Adjustment range:** YES, NO.

**Standard value:** YES.

### OTDL – Association of the relay with the delay for oil shutdown

It activates the relay according to the actuation of the oil shutdown delay.



**Adjustment range:** YES, NO.

**Standard value:** NO.



The following parameters contain settings for windings 1, 2 and 3. These settings are repeated for all of them.

The 'x' indicates the winding number.

**Example:** (W1AL), (W2AL) and (W3AL).

### W'x'AL - Association of the relay with the alarm due to winding 'x' temperature



It activates the relay according to the activation of the alarm due to winding 'x' temperature.

**Adjustment range:** YES, NO.

**Standard value:** YES.



### W'x'DL - Association of the relay with the delay for shutdown of the winding 'x'



It activates the relay according to the activation of the 'x' winding shutdown delay.

**Adjustment range:** YES, NO.

**Standard value:** NO.

### 5.6.3 FACT Submenu



It allows access to factory parameters. It is for the exclusive use of Treetech technical assistance and is password protected, not accessible to the equipment operator.





## 6 Commissioning for entry into service

Once the equipment has been installed, putting it into service must follow the following basic steps:

- ✓ Check the mechanical and electrical installations, in accordance with the recommendations in chapter 2.4 of this manual. Also check the correctness of electrical connections (for example, through continuity tests);
- ✓ Make sure that no secondary current transformers (CTs) are open during the installation and operation of temperature monitors;
- ✓ If dielectric strength tests are carried out on the wiring (applied voltage), disconnect the cables connected to the ground terminal of the TM to avoid destroying the overvoltage protections existing inside the device. These protections are internally connected between the input/output terminals and ground, clamping the voltage at around 300 V. The application of high voltages for a long period (for example, 2 kV for 1 minute) would cause the destruction of such protections;
- ✓ Reconnect the ground cables to the TM terminals, if they were disconnected for applied voltage tests;
- ✓ Power the TM with any voltage in the range of 85 to 265Vdc/Vac 50/60Hz;
- ✓ Carry out all parameterization of the TM, according to the instructions in this manual;
- ✓ Using a continuity meter, test the actuation of the alarm, shutdown and forced cooling contacts. The actuation of the contacts can be forced, for example, by reducing the respective settings to values lower than the current measurements;
- ✓ Make sure that no operation of the contacts will interact with other systems during this phase. If necessary, isolate all control, alarm and shutdown contacts by simply disconnecting the lower removable connector (terminals 1...32);
- ✓ Connect temperature calibrator, resistive decade or check the temperature of the PT100 connected to each TM measurement input, checking if the measurements are correct;
- ✓ Using a DC milliammeter, check whether the current loop outputs have values consistent with the corresponding temperature values;
- ✓ Reconnect any contacts that may have been isolated, reconnecting the lower connector (terminals 1...32).



## 7 Troubleshooting

The Temperature Monitor for Oil and Windings — TM constantly checks the integrity of its functions and the sensors and modules connected to it. Any anomaly detected is signaled via its fault contact. Furthermore, messages indicating the fault will be displayed on the TM display, assisting in the diagnosis process.

If you encounter difficulties or problems operating the system, we suggest consulting the possible causes and simple solutions presented in the following items. If this information is not sufficient to resolve the difficulty, please contact Treetech CS or your authorized representative.

### 7.1 Equipment presents self-diagnosis messages on the display

The self-diagnosis function implemented in the TM device allows any problems external to the equipment, or even internal faults, to be detected and diagnosed, allowing in most cases the user to identify and correct problems quickly.

The TM has 2 self-diagnosis indexes “SDG1” and “SDG2”, which appear alternating along with the code on the display in the event of an anomaly.

The TM displays the self-diagnosis code flashing slowly (about 1 second).



Figure 19 - Indication of self-diagnosis in TM

#### 7.1.1 Viewing self-diagnosis memory and alarm memory

The TM firmware constantly checks the integrity of its functions and the temperature sensors connected to it through its self-diagnosis circuits and algorithms. Any anomaly detected is signaled through the fault contact and through self-diagnosis messages indicated on the equipment display, assisting in the process of diagnosing and resolving the fault.

The Self-Diagnosis Memory function allows you to know all diagnostic events that occurred in the TM, such as bad contacts in the temperature sensor wiring or internal faults. This memory is non-volatile and cumulative, that is, it allows you to know all the events that occurred, but not when they occurred.

Therefore, the Alarm Memory function allows you to know all the events that occurred in the TM, such as activation of forced cooling, alarms, and shutdowns. This memory is non-volatile and cumulative, that is, it allows you to know all the events that occurred, but not when they occurred. If you have two different events, the result presented in the position relative to this event is a sum of them.







The Self-Diagnosis Memory and the alarm memory are accessed by pressing the keys  and  sequentially. There are two self-diagnosis memory screens, identified by the acronyms DGM1 and DGM2 and an alarm memory screen, identified by the acronym ALM, which can be consulted by pressing the keys  and . On each of the screens, the acronym DGM1 or DGM2 is indicated alternately with a numeric code that identifies the events that have occurred.



Figure 20 - Querying the self-diagnosis memory



Figure 21 - Alarm memory query screen

To clear (reset) the self-diagnosis memory, press the  for 5 seconds. If there is an active diagnosis, the memory will be reset indicating its occurrence. Press the key  to return to the indications screen.



To check the procedure in case of self-diagnosis and possible errors generated by the TM, follow the instructions by clicking on the link below or scanning the QR code to be redirected to Treetech's CS.

Self-diagnosis:



## 8 Technical data and type tests

### 8.1 Technical data

Table 11 – Technical data

| Hardware                          | Range/Description   |
|-----------------------------------|---|
| Supply voltage                    | 85...265 Vac/Vdc  |
| Maximum consumption               | <12 W   |
| Operating temperature             | -40...85 °C   |
| Degree of protection              | IP20  |
| Fixing                            | Panel   |
| <b>Inputs</b>                     |   |
| 2 RTDs                            | PT100 Ω at 0 °C 3-wire, range: -55...200 °C   |
| 3 Current readings (CT)           | External clip-on CT 0...10 Aca rms  |
| Minimum value for current reading | 100 mA  |
| <b>Outputs</b>                    |   |
| Relay output                      | 5 NO relays (Normally Open) + 3 NC relays (Normally Closed)   |
| Dielectric strength               | 300 Vrms in normally open<br>400 Vrms in normally closed  |
| Maximum switching voltage         | 277 Vac / 125 Vdc normally open<br>400 Vac / 300 Vdc in normally closed                               |
| Maximum switching current         | 5.0 A @ 250 Vac; 1250 VA in normally open<br>6.0 / 5.0 A @ 250 Vac; 1250 / 1500 VA in normally closed |
| Resistive load                    | 0.4 A @ 125 Vdc; 50 W in normally open<br>0.50 A @ 125 Vdc; 62.5 W in normally closed                 |
| Current loop output ranges        | 0...1 mA, 10 kΩ<br>0...5 mA, 2 kΩ<br>0...10 mA, 1kΩ<br>0...20 mA, 500 Ω<br>4...20 mA, 500 Ω           |
| <b>Communication interface</b>    |   |
| Communication protocols           | DNP3<br>Modbus® RTU   |
| Communication ports               | 2 RS-485 (based on TIA-485-A standard)<br>1 USB Device type C   |
| <b>Dimension and weight</b>       |   |
| Dimension                         | 98 mm x 36 mm x 98 mm   |
| Weight                            | 230 grams   |



## 9 Order specification

### 1. Product name

- Temperature Monitor for Oil and Windings - TM.

### 2. Quantity

- The number of units.

### 3. Options

More than one optional item can be specified for the same equipment.

- PCOL - Pre-cooling;
- OLTD - OLTC temperature differential;
- TM FUNC 3ENR – 3 Winding monitoring.

### 4. Accessories

- Inform which accessories and quantity.



# Treetech

Treetech Tecnologia  
Rua José Alvim, 112, Centro  
Cep 12940-750 – Atibaia/SP  
+55 11 2410 1190  
[www.treetech.com.br](http://www.treetech.com.br)